



# Microwave Flexible Cable Assembly



# CATALOG



2022

# About Us

RF ONE is an **ISO 9001** certified supplier of high quality RF, Microwave and mmWave components & cable assemblies from China. Since 2002 we have been dedicated to the design and manufacturing of RF attenuators, terminations and other passive components. As the industry evolved, RF ONE has grown and expanded our lines to keep meeting customer needs. Our products are used widely in commercial, industrial and military applications including wireless, satellite, defense, test & measurement etc.

RF ONE has been continuously pursuing improvement and dedicating to product innovation, granted with 13 patents in the range of RF Attenuators, mmWave terminations, low PIM Passive Components etc.

We have established long term solid partnership with worldwide sales representatives and distributors. RF ONE is the approved vendor to **Indra, Viavi Solutions, Teledyne Paradise Datacom** and also is qualified supplier to **ACE Technologies Corp, JCET, Ericsson** and more.

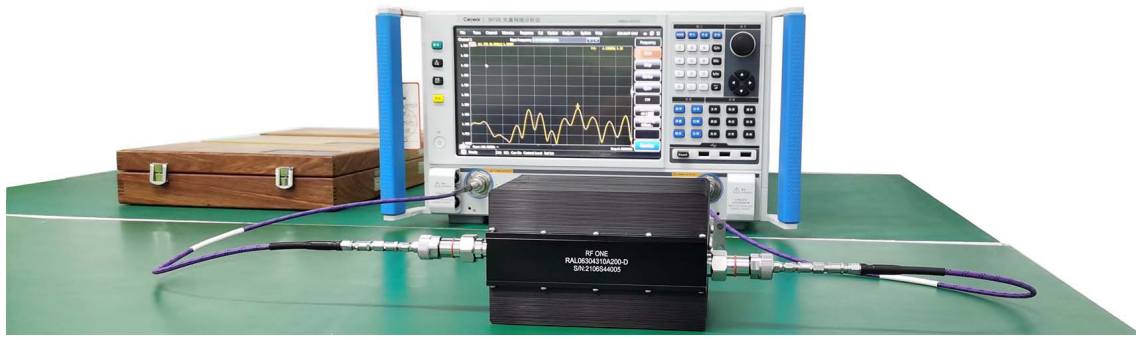

Main categories include:

- Coaxial Fixed Attenuator/Termination (DC-4GHz through 67GHz, 2W-2kW)
- DC Block (9kHz up to 67GHz)
- mmWave Coax Adapter/Connector(Up to 110GHz)
- Low PIM Component (170dBc termination/attenuator/cable/adapter)
- Waveguide Product (adapter/attenuator/termination/coupler)
- Power Divider
- Flexible Cable Assembly (Up to 110GHz)



ISO 9001 Certificate

Part of Patent Certificates

## Introduction of Cable and Cable Assembly

RF ONE offers a complete line of high performance microwave flexible cables up to 110 GHz, with a variety of options in cable size, flexibility, loss and affordability. Benefiting from over twenty-year experience in designing and manufacturing cables & connectors, we provide highly reliable cable assemblies widely used in test & measurement, high frequency inter-connection, 5G system as well as in harsh environments such as defense, naval etc. Cables and assemblies are produced in-house, every cable assembly is tested for insertion loss, VSWR and shipped with an individual test plot.

## Features and Benefits

- Versatile cable selections in different flexibility, loss and affordability
- Low loss cables available to 18, 26.5, 40, 50, 67, 110 GHz
- Proven phase stability vs. temperature and flexure
- Precise phase match available
- Various ruggedized armor and connector options
- Competitive price and very quick delivery
- Custom designs available

## Testing and Inspections

RF ONE performs below inspections and tests for cable and cable assemblies.

Acceptance Testing		Qualification Testing
Test Items	Inspection Rate	Test Items
Insertion loss	100%	Minimum Static Bend Radius
VSWR	100%	Minimum Dynamic Bend Radius
Amplitude vs.Shaking	100%	Flex life
Connector Interface	100%	Connector Retention
Assembly Marking	100%	Coupling Mechanisim Proof Torque
Assembly Length	100%	Insertion loss vs. Temperature
Workmanship	100%	Phase Stability vs. Temperature
Cable Diameter	100%	Phase Change vs. Bending
Cable Weight	Sampling each lot	Thermal Shock
Velocity of Propagation	Sampling each lot	Vibration
Dielectric Withstanding Voltage	Sampling each lot	Cold Bend
Characteristic Impedance	Sampling each lot	Salt Spray
Tensile Strength and Elongation	Sampling each lot	Stress Crack Resistance
Center Conductor Adhesion	Sampling each lot	Aging Stability

Notes:

1. Phase Stability test for phase stable cables only.
2. Other environmental or electrical tests can be performed when required.

## Production and Test Facilities

RF ONE is committed to providing high quality and reliable products to our worldwide customers. Our ISO 9001 certified facilities are equipped with a range of production equipments and test instruments.



Cable Production



Cable Assembly Shop



Warehouse



Environmental Test

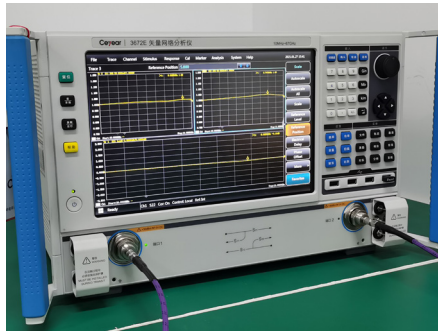

Vector Network Analyzer

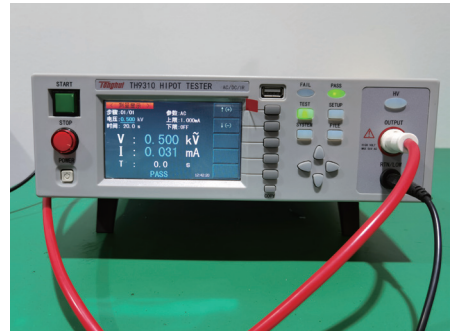

HIPOT Tester



Time Domain Reflectometry

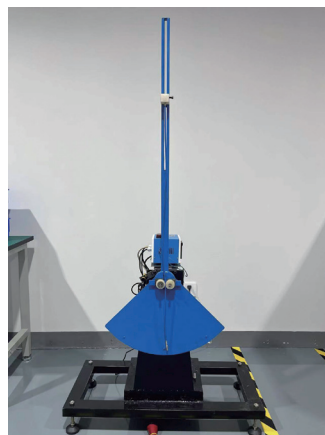

Flex Life Tester

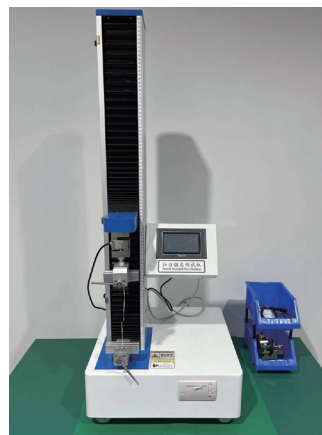

Tensile Strength Tester



Thermal Shock Test Chamber

## Contents

### Part 1 Selection Guide

Page 1

### Part2 Series of Cable and Cable Assembly



#### **PL Series-Ultra-low Loss Phase and Amplitude Stable Flexible Cable** Page 2

- Minimal phase and attenuation change versus flexure
- Ultra-low loss & VSWR, up to 110 GHz
- Robust and reliable, ruggedized armors available
- Broad options in frequency, cable size, connector



#### **FL Series-Long Flex Life Triple-shielding Flexible Cable** Page 10

- Long flex life, ideal as test or interconnect cables
- Triple shielding with superior shielding effectiveness
- Torque resistant and high pull off strength
- Low loss and good amplitude stability with flexure



#### **MB Series-Tight Bend Triple-shielding Flexible Cable** Page 14

- Flexible alternatives to semi-rigid cables
- Allowing multiple times of bending from connector end
- Eliminating use of right angle connectors
- Small bending radius, ideal for high density interconnect

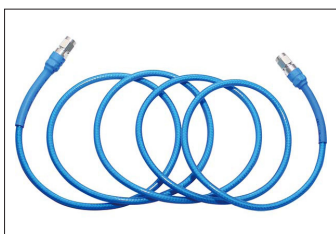

#### **UF Series-Ultra-Flexible Phase Stable Low Loss Cable** Page 18

- Ultra-flexible with stranded inner conductor
- Excellent phase stability over to 40GHz
- Durable design, long flex life
- Ruggedized armors available

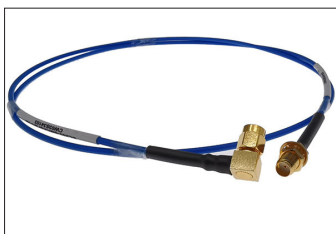

#### **SP Series-Low Loss Flexible Cable Replacing Semi-flexible Cable** Page 22

- Superior flexible alternative to semi-flexible cables
- Up to 67 GHz, available in 047, 086 and 141 sizes
- Highly competitive pricing, from stock
- Lower loss than equivalent hand-formable cables

## Contents



### **EL Series**-Economical Low Loss Flexible Cable

Page 26

- Attractive cost vs performance ratio
- Good amplitude stability vs flex and shaking
- Low Loss with LD-PTFE dielectric wrapping

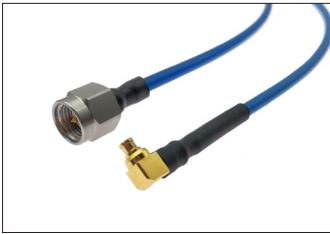

### **TP Series**-Temperature Phase Stable Cable

Page 30

- Excellent temperature phase stability 300PPM
- PTFE “Knee” is Non-existent
- Low loss to 40GHz
- Small bending radii and low profile for easy routing



### **Armored Cable Assemblies**

Page 33

- Repeatable and precise performance, ideal for bench-top test
- Available in SMA, N, 3.5mm, 2.92mm, 2.4mm, 1.85mm and 1.0mm connectors
- Multi-layer armors against crush and abrasion
- Long service life, 20,000 flex cycles



### **Phase Matched Cable Assemblies**

Page 37

- Phase matching available up to 110 GHz
- Precise matching in electrical length or time delay
- Available  $\pm 4^\circ$  @ 18 GHz, or  $\pm 1$  ps
- Fast delivery, competitive price

## **Part 3 Engineering Information**

Page 38



- ▶ Phase Stability Test with Flexure
- ▶ Phase Stability Test over Temperature
- ▶ Phase Matching of Cable Assemblies
- ▶ Typical Cable Structure
- ▶ General Assembly Information

## **Part 4 Frequently Asked Questions**

Page 45

## Selection Guide

In order to simplify the cable selection process, we have classified these flexible cables into different series and further rated them by loss, flexibility, phase stability etc.

Cable Series Designation	Part Number	Max Operation Freq(GHz)	Super Flexibility	Low Loss	Phase Stability vs. Flex	Phase Stability vs. Temp	High Power	Low Profile	High Mechanical Strength with multi-shielding	Additional Remarks
Ultra-Low Loss Phase and Amplitude Stable PL Series	PL180	110	★★★★	★★	★★	★		★★★★		Precision Test or high end interconnect
	PL220	67	★★	★★	★★	★★		★★		
	PL230P	67	★★	★★	★★★★	★		★★	★★	
	PL360P	50		★★	★★★★	★			★★	
	PL360	40		★★★★	★★	★★				
	PL380P	40		★★★★	★★★★	★★			★★	
	PL390P	40		★★★★	★★★★	★★			★★	
	PL520	26.5		★★★★	★★★★	★★				
	PL520P	26.5		★★★★	★★★★	★★			★★	
	PL800	18		★★★★	★★★★	★★	★★			
PL1200	10		★★★★	★★★★	★★	★★★★				
Long Flex Life Triple-Shielding FL Series	FL460	26.5		★★	★				★★★★	General Purpose Test or interconnect
	FL520	18		★★	★				★★★★	
	FL620	18		★★	★		★		★★★★	
Low cost flexible alternative to semi-flexible SP Series	SP160	67	★★★★					★★★★		Interconnect use
	SP280	40	★					★		
	SP400	18								
Tight Bend Replacing Semi-rigid MB Series	MB200	40	★★		★			★★	★★★★	Super small bending radius, bend-to-end
	MB250	40	★★		★	★		★	★★★★	
	MB250L	40	★★		★	★		★	★★★★	
	MB260L	50	★★		★★			★	★★★★	
	MB360	26.5	★		★				★★★★	
Ultra-Flexible Phase Stable Low Loss UF Series	UF360	40	★★★★	★★	★★★★	★★				Stranded SPC center conductor
	UF450	40	★★★★	★★	★★★★	★				
	UF520	26.5	★★★★	★	★★★★	★				
	UF550	26.5	★★★★	★★	★★★★	★★				
Economical Low Loss Interconnect EL Series	EL280	26.5	★	★★	★			★		Low cost
	EL350	18		★★	★					
	EL520	18		★★	★					
	EL780	13.5		★★	★		★			
Temperature Phase Stable TP Series	TP220		★★	★	★★	★★★★		★★		300PPM

★ Good    ★★ Very good    ★★★ Excellent    ★★★★ Outstanding

## Overview PL Series

### Ultra-low Loss Phase and Amplitude Stable Flexible Cable

PL series from RF ONE are phase and amplitude stable low loss cables with max operating frequency options of 18GHz, 26.5GHz, 30GHz, 40GHz, 50GHz, 67GHz and 110GHz. Using micro-porous PTFE dielectrics which provide consistent performance over temperature changes, these cables are ideally for high frequency signal transmission between systems or used in test instruments when low loss and stability are critical. PL series cable assemblies are available with a broad selection of connectors and ruggedized armors. Bulk cables available as well.

### Features

- Minimal phase and attenuation change versus flexure
- Robust for dynamic use with multiple inter-layers
- Very low VSWR and loss, typ VSWR 1.30 to 67GHz
- Broad options of frequency, cable size, connector and armor



### Cable Data

Part Number	Outer Diameter(mm)	Static Bend Radius(mm)	Max Operation Freq(GHz)	Phase Stability @ max freq	Loss(dB/m @ max freq)	Avg Power(watts@ max freq)
PL180P	1.8	10	110	<±12°@110GHz	13.1	3
PL220	2.2	11	67	<±8°@67GHz	6.0	29
PL230P	2.6	11	67	<±7°@67GHz	6.0	29
PL360P	3.6	18	50	<±5°@50GHz	3.3	55
PL360	3.6	18	40	<±6°@40GHz	2.6	75
PL380P	3.8	18	40	<±5°@40GHz	2.2	74
PL390P	3.9	18	40	<±5°@40GHz	2.6	75
PL520	5.2	25	26.5	<±5°@26.5GHz	1.3	160
PL520P	5.4	26	26.5	<±5°@26.5GHz	1.3	160
PL800	7.9	40	18	<±5°@18GHz	0.7	398
PL1200	12.0	60	10	<±4°@10GHz	0.4	867

### Cross Reference

RF ONE Model	GORE	Insulated Wire	Micro-Coax	Harbour	TIMES	Semflex
PL220, PL230P	CXN3506					
PL360, PL360P	CXN3507	1401	UFB142A			
PL520, PL520P	CXN3449	1801	UFB205A		HF190	
PL800	CXN3450	2801	UFB311A	LLS290	HF290	LA290



## PL Series

### Ultra-low Loss Phase and Amplitude Stable Flexible Cable

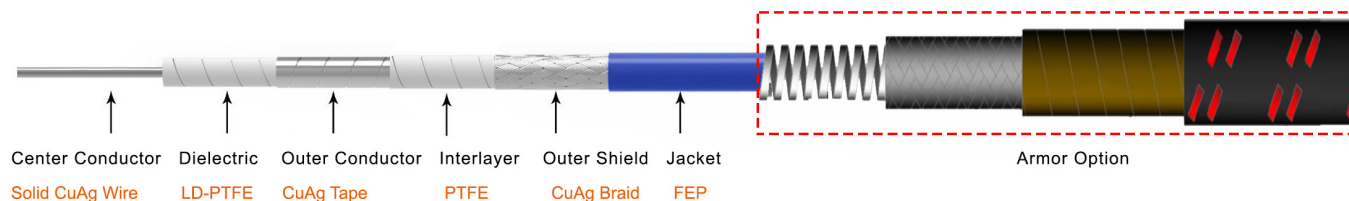

	PL180	PL220	PL230P	PL360P	PL360	PL380P
<b>Cable Construction(Diameter in mm)</b>						
Center Conductor	0.29	0.51	0.51	0.72	0.91	1.02
Dielectric	0.94	1.43	1.60	2.15	2.50	2.85
Outer Conductor	1.06	1.55	1.70	2.30	2.66	3.06
Interlayer	1.20	/	2.00	2.60	/	3.22
Outer Shield	1.50	1.85	2.25	3.05	3.06	3.67
Jacket	1.80	2.20	2.60	3.60	3.60	3.80
*Armor Option	AL380	/	AL500&AL640	AL640	AL640	AL640
* Please refer to Page 33 for armor details.						
<b>Mechanical</b>						
Min.Bending Radius Static	10mm	11mm	13mm	18mm	18mm	19mm
Min. Bending Radius Repeated	20mm	22mm	26mm	36mm	36mm	38mm
Weight	9g/m	18g/m	18g/m	34g/m	33g/m	37g/m
Temperature range	-50 ℃ to +150 ℃ (cable only), -50 ℃ to +85 ℃ (cable assembly)					
<b>Electrical</b>						
Operating Frequency	DC-110 GHz	DC-67 GHz	DC-67 GHz	DC-50 GHz	DC-40 GHz	DC-40 GHz
Impedance	50 Ω	50 Ω	50 Ω	50 Ω	50 Ω	50 Ω
Velocity of Propagation	82%	81%	74%	76%	82%	82%
Shielding Effectiveness	>90 dB	>90 dB	>90 dB	>90 dB	>90 dB	>90 dB
Withstanding Voltage	500 V	500 V	500 V	1000 V	1000 V	1000 V
**Mechanical Phase Stability	<±12°	<±8°	<±7°	<±5°	<±6°	<±5°
***Amplitude Stability vs Shaking	<±0.2dB	<±0.2dB	<±0.15dB	<±0.1dB	<±0.15dB	<±0.1dB
Temp Phase Stability (-40 ℃ to +85 ℃ )	<1500ppm	<700ppm	<1500ppm	<1300ppm	<680ppm	<680ppm
Cable attenuation at 25 ℃	see graph					
Power handling	see graph					
** Wrap the cable 360 degree around a mandrel whose diameter is ten times of cable outer diameter.						
*** Shake the cable assembly at a rate of 90 times per minute at a height of 10 cm.						

## PL Series

### Ultra-low Loss Phase and Amplitude Stable Flexible Cable

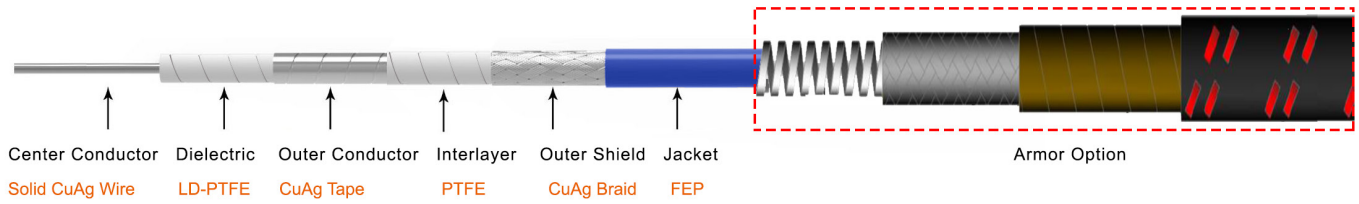

	PL390P	PL520	PL520P	PL800	PL1200
<b>Cable Construction(Diameter in mm)</b>					
Center Conductor	0.91	1.45	1.45	2.30	3.80
Dielectric	2.50	4.00	4.00	6.30	10.40
Outer Conductor	2.70	4.20	4.20	6.50	10.78
Interlayer	3.00	/	4.45	/	/
Outer Shield	3.46	4.70	4.90	7.10	11.35
Jacket	3.90	5.20	5.40	7.85	12.00
*Armor Option	AL640	AL780	AL780	AL1050	/
* Please refer to Page 33 for armor details.					
<b>Mechanical</b>					
Min.Bending Radius Static	18mm	25mm	26mm	40mm	60mm
Min. Bending Radius Repeated	36mm	52mm	52mm	80mm	120mm
Weight	35g/m	52g/m	63g/m	130g/m	280g/m
Temperature range	-50℃ to +150℃ (cable only), -50℃ to +85℃ (cable assembly)				
<b>Electrical</b>					
Frequency	DC-40 GHz	DC-26.5 GHz	DC-26.5 GHz	DC-18 GHz	DC-10 GHz
Impedance	50 Ω	50 Ω	50 Ω	50 Ω	50 Ω
Velocity of Propagation	82%	83%	83%	83%	83%
Shielding Effectiveness	>90 dB	>90 dB	>90 dB	>90 dB	>90 dB
Withstanding Voltage	900 V	1500 V	1500 V	2000 V	2000 V
*Mechanical Phase Stability	<±5°	<±5°	<±5°	<±5°	<±4°
***Amplitude Stability vs Shaking	<±0.1dB	<±0.15dB	<±0.1dB	<±0.1dB	<±0.1dB
Temp Phase Stability (-40℃ to +85℃)	<680ppm	<550ppm	<550ppm	<500ppm	<500ppm
Cable attenuation at 25℃	see graph				
Power handling	see graph				
** Wrap the cable 360 degree around a mandrel whose diameter is ten times of cable outer diameter.					
*** Shake the cable assembly at a rate of 90 times per minute at a height of 10 cm.					

### Attenuation (nominal values at +25 °C ambient temperature)

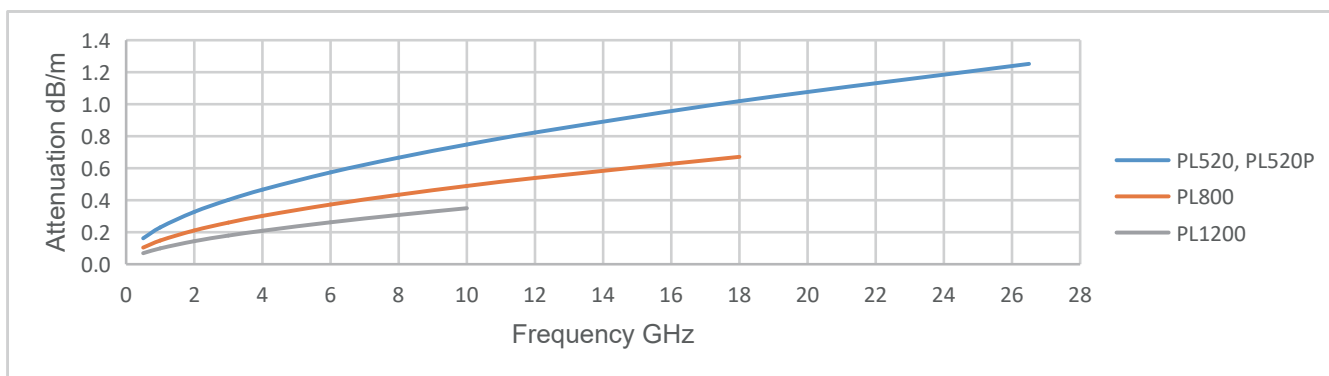
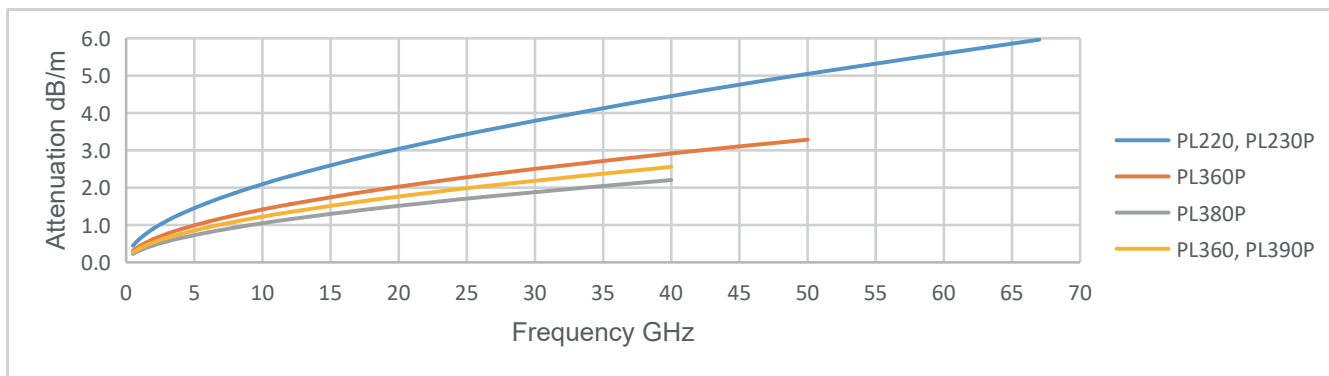

### Power handling (maximum values at 40 °C ambient temperature and sea level)

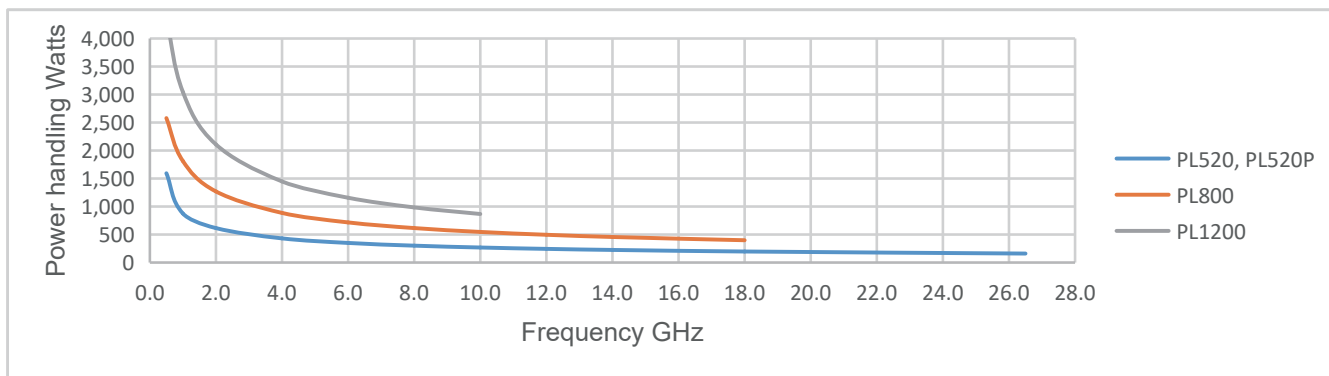
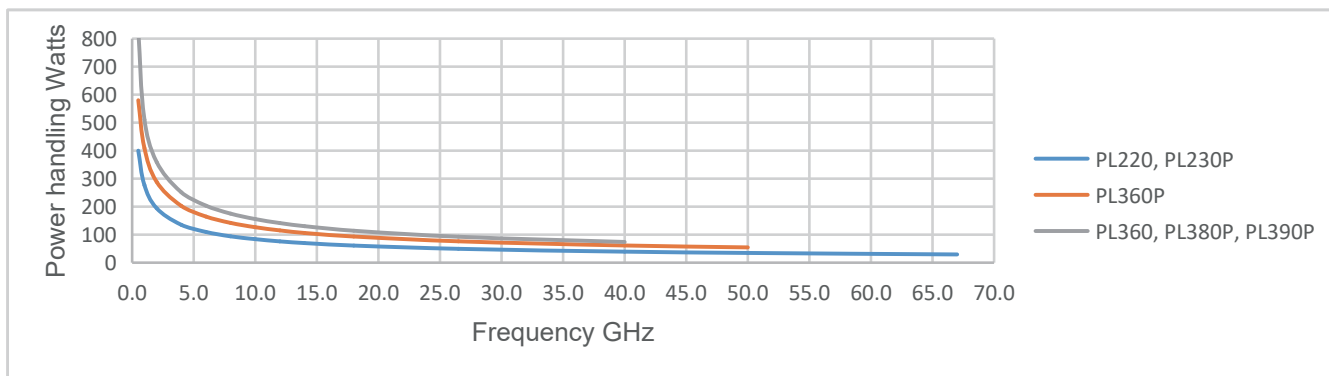

## Mechanical Phase Stability

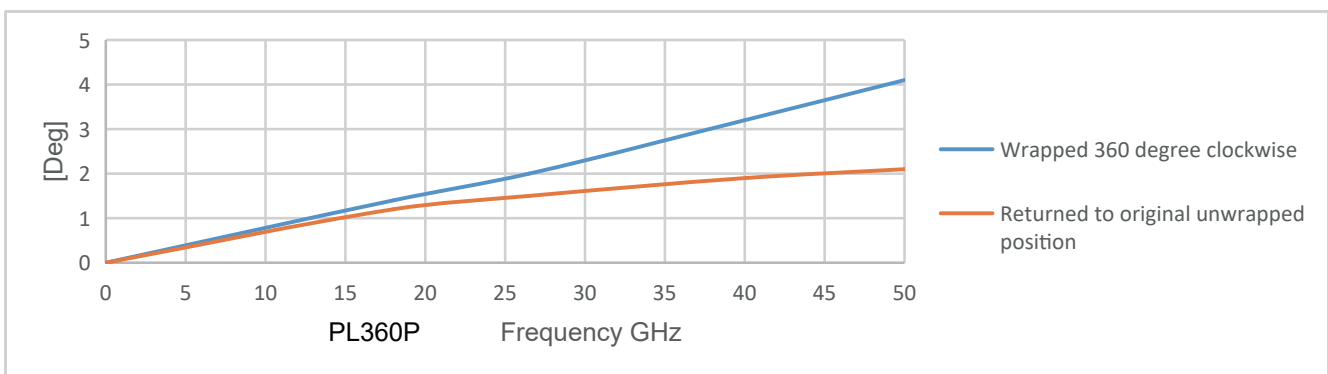
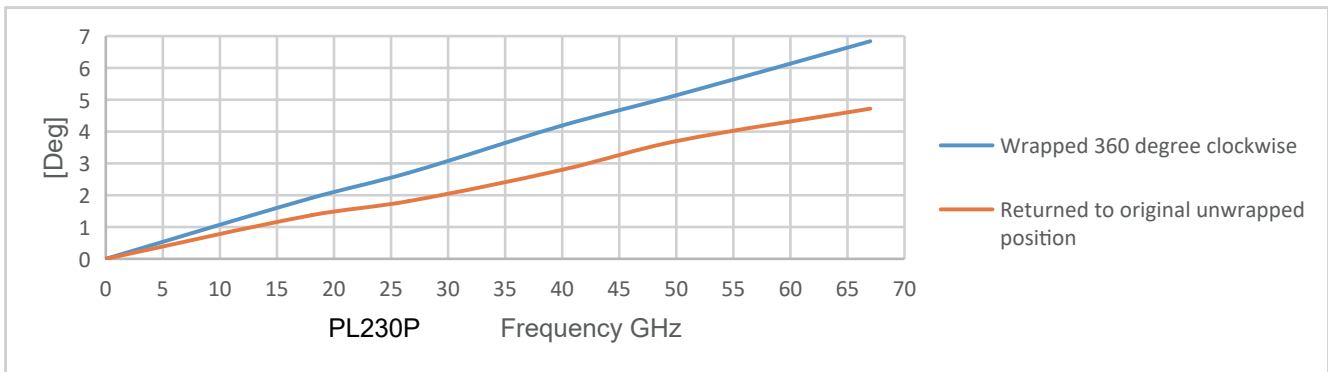

RF ONE performs the test of Mechanical Phase Stability of Cable Assembly in below procedures.

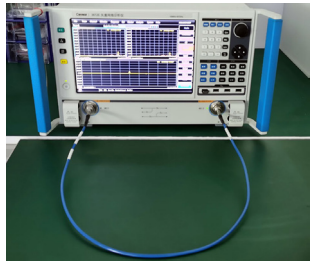
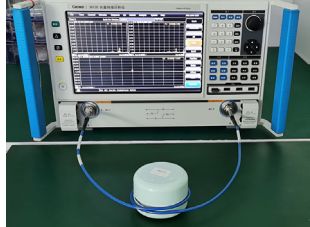
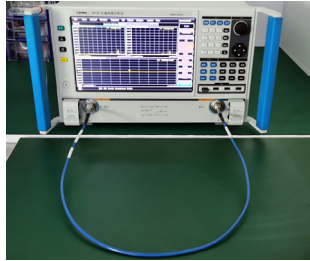
Steps	Test Method	Diagram
Initial Test	<ol style="list-style-type: none"> <li>1) Connect the two ports of cable under test(CUT) with VNA, the cable is held in an initial unwrapped position and is measured in the phase and attenuation.</li> <li>2) Normalize VNA in the phase.</li> </ol> <p>*CUT is 1 meter in length.</p>	
Test with cable wrapped 360 degree clockwise	<ol style="list-style-type: none"> <li>1) Disconnect the CUT cable and wrap it 360 degree clockwise around a mandrel(diameter is ten times of cable outer diameter).</li> <li>2) The CUT cable is held in such position for measurement, record the max phase and attenuation change over frequency range.</li> </ol>	
Test with cable returned to original unwrapped position	<ol style="list-style-type: none"> <li>1) Disconnect the CUT cable and return it to its original unwrapped position.</li> <li>2) The CUT cable is held in such position for measurement, record the max phase change.</li> <li>3) The worst-case phase variation in the above procedure is recorded as the phase stability value.</li> </ol>	

## Amplitude Stability vs Shaking

Shake the cable assembly at a rate of 90 times per minute at a height of 10 cm.

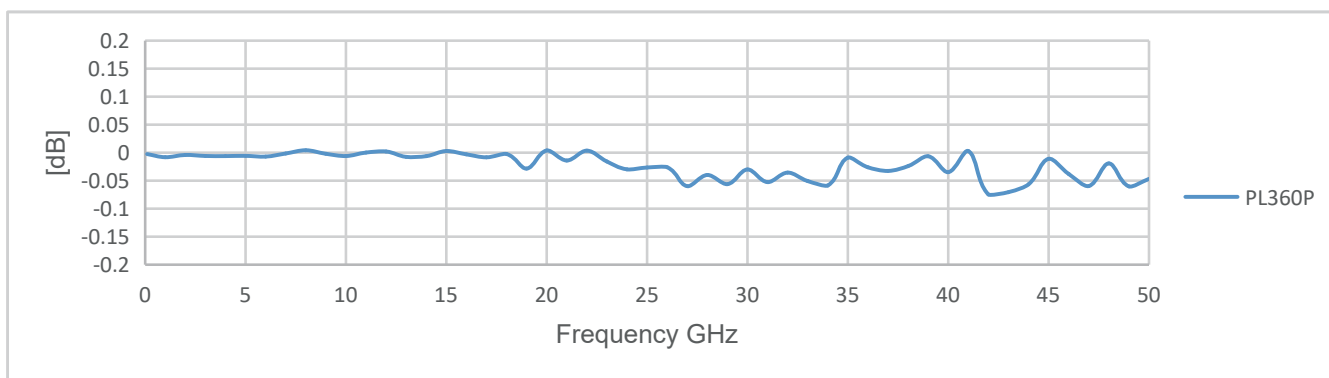
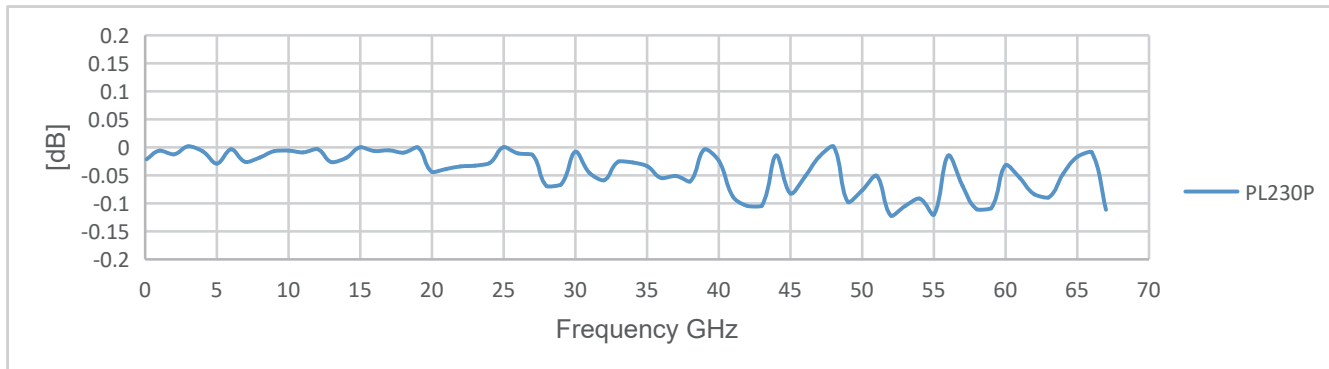

## Temperature Phase Stability

Test procedure is detailed on Page 40.

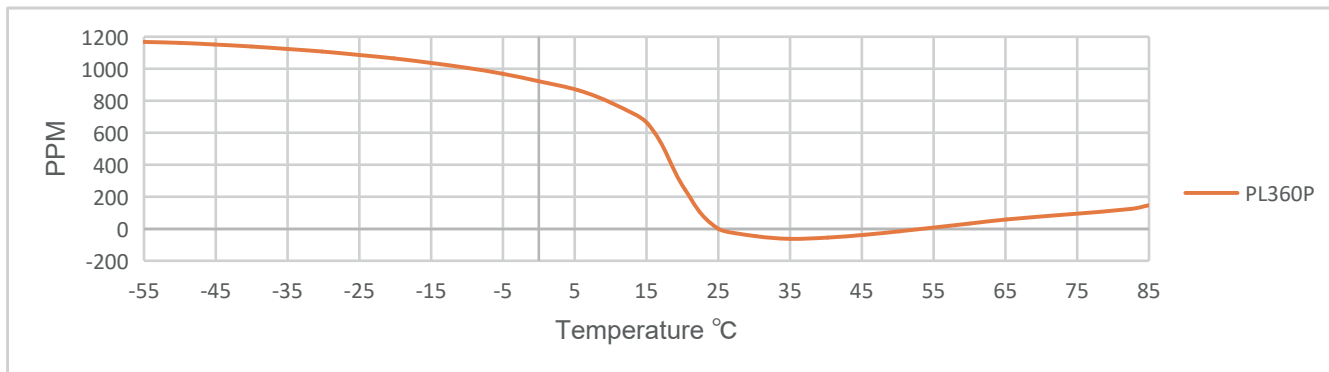
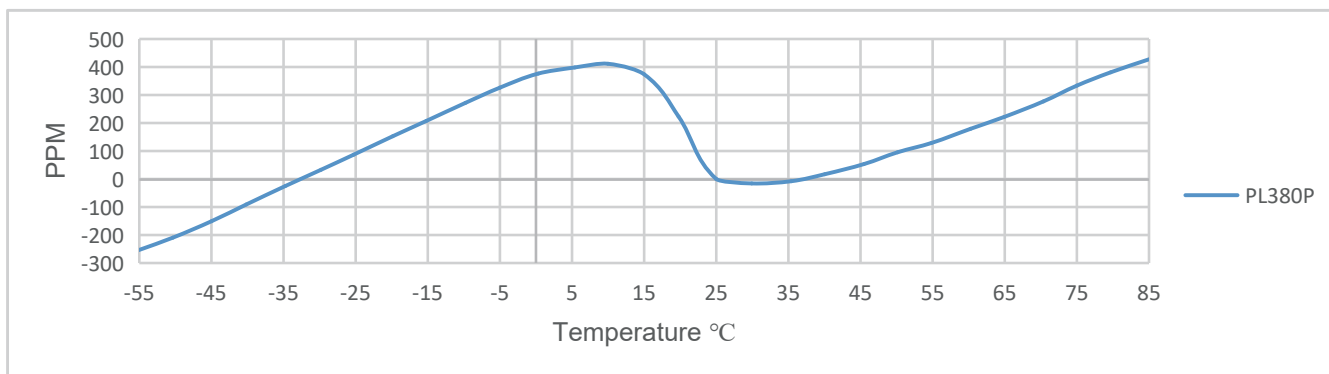

## Available Connectors

Cable P/N	Connectors	Gender	Orientation	Mounting	Max Freq (GHz)	VSWR Max
PL180P	1.0mm	M/F	Straight	Standard	110	1.45
PL220	SMA	M/F	Straight	Standard	26.5	1.3
	2.92mm	M/F	Straight	Standard	40	1.3
	2.4mm	M/F	Straight	Standard	50	1.35
	1.85mm	M/F	Straight	Standard	67	1.4/1.45
	SSMA	Male	Straight	Standard	33	1.4
	SMP	Female	Right Angle	Standard	26.5	1.35
	SMP	M/F	Straight	Standard	40	1.4
	SSMP	M/F	Straight	Standard	67	1.5
PL230P	SMA	M/F	Straight	Standard	26.5	1.25
	2.92mm	M/F	Straight	Standard	40	1.3
	2.4mm	Male	Straight	Standard	50	1.35
	1.85mm	M/F	Straight	Standard	67	1.4/1.45
PL360P	N	Male	Straight	Standard	18	1.3
	SMA	M/F	Straight	Standard	26.5	1.25
	3.5mm	M/F	Straight	Standard	33	1.3
	2.92mm	M/F	Straight	Standard	40	1.3
	2.92mm	M	Right Angle	Standard	38	1.4
	2.92mm	Female	Straight	Bulkhead	40	1.4
	2.4mm	M/F	Straight	Standard	50	1.35
PL360	N	Male	Straight	Standard	18	1.35
	SMA	M/F	Straight	Standard	26.5	1.3
	SMA	Male	Right Angle	Standard	18	1.35
	3.5mm	M/F	Straight	Standard	33	1.3
	2.92mm	M/F	Straight	Standard	40	1.3
	2.92mm	Male	Right Angle	Standard	38	1.4
	2.4mm	Male	Straight	Standard	40	1.35
	SSMA	Male	Right Angle	Standard	33	1.4
PL380P	SMA	Male	Straight	Standard	26.5	1.3
	2.92mm	Male	Straight	Standard	40	1.3
PL390P	N	Male	Straight	Standard	18	1.35
	SMA	M/F	Straight	Standard	26.5	1.3
	SMA	Male	Right Angle	Standard	18	1.35
	3.5mm	M/F	Straight	Standard	33	1.3
	2.92mm	M/F	Straight	Standard	40	1.3

## Available Connectors

Cable P/N	Connectors	Gender	Orientation	Mounting	Max Freq (GHz)	VSWR Max
PL520	N	M/F	Straight	Standard	18	1.3/1.4
	N	Male	Right Angle	Standard	18	1.35
	TNC	Male	Straight	Standard	18	1.35
	TNC	Male	Right Angle	Standard	18	1.4
	3.5mm	Male	Straight	Standard	26.5	1.3
	SMA	M/F	Straight	Standard	26.5	1.3
	SMA	Female	Straight	Bulkhead	18	1.3
PL520P	SMA	Male	Right Angle	Standard	18	1.35
	N	Male	Straight	Standard	18	1.25
	N	Male	Right Angle	Standard	18	1.35
	N	Female	Straight	Standard	18	1.35
	TNC	Male	Straight	Standard	18	1.35
	SMA	Male/Female	Straight	Standard	26.5	1.3
	SMA	Male	Right Angle	Standard	18	1.35
	3.5mm	Male	Straight	Standard	26.5	1.3
PL800	N	M/F	Straight	Standard	18	1.3
	N	Male	Right Angle	Standard	18	1.35
	TNC	M/F	Straight	Standard	18	1.35
	TNC	Male	Right Angle	Standard	18	1.4
	SMA	M/F	Straight	Standard	18	1.3
	SMA	Male	Right Angle	Standard	18	1.35
PL1200	N	Male	Straight	Standard	6	1.3
	DIN 7/16	Male	Straight	Standard	6	1.3

Note: Other connectors available upon request.

## How to Order

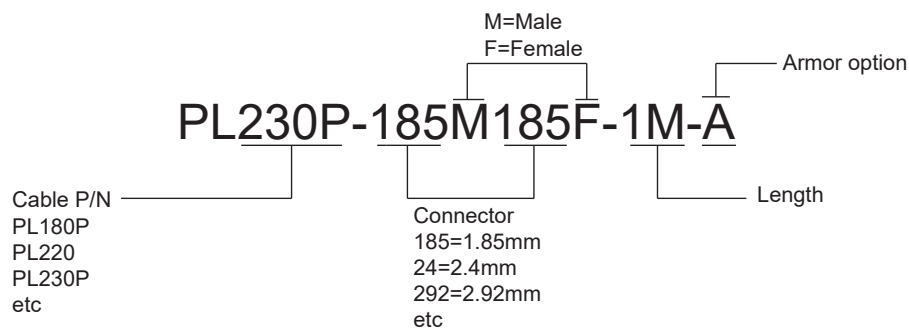

## Overview FL Series

### Long Flex Life Triple-shielding Flexible Cable

FL series from RF ONE are long flexing life low loss cables with max operating frequency options of 18GHz, 26.5GHz. These cables are highly robust with triple shield construction of woven flat braid, foil, and round braid, delivering excellent shielding effectiveness and high pull strength. FL series cable assemblies can be widely used in both interconnection and test applications, where low loss and harsh handling are required.

### Features

- Long flex life, ideal as test cables or as interconnect cables in harsh condition
- Superior shielding effectiveness
- Torque resistant and high pull off strength
- Low loss and good phase & amplitude stability with flexure



### Cable Data

Part Number	Outer Diameter(mm)	Static Bend Radius(mm)	Max Operation Freq(GHz)	Loss (dB/m @ max freq)	Avg Power (watts@ max freq)
FL460	4.6	20	26.5	1.8	128
FL520	5.2	25	18	1.3	166
FL620	6.2	32	18	1.0	202

### Cross Reference

RF ONE Model	Huber Suhner	TIMES	Harbour Industries	ASTROLAB	Semflex	Micro-Coax
FL460	SUCOFLEX102	SFT-142	LL160	32022	HP160S	UFA147A
FL520	SUCOFLEX104	SFT-205	LL142	32055	HP190S	UFA205A
FL620		SFT-304	LL235	32051	HP305S	



## FL Series

### Long Flex Life Triple-shielding Flexible Cable

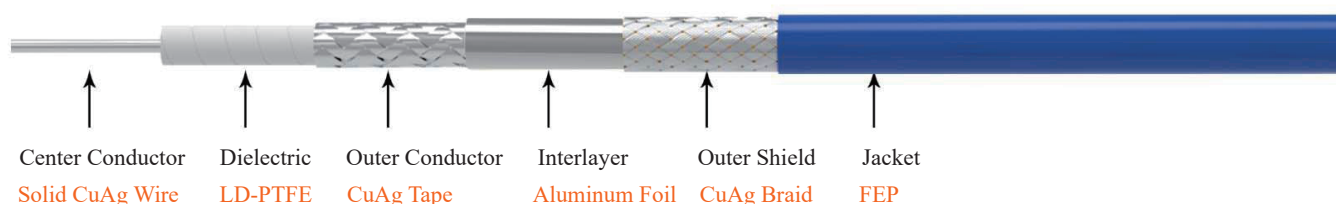

	FL460	FL520	FL620
<b>Cable Construction</b> (Diameter in mm)			
Center Conductor	1.02	1.29	1.57
Dielectric	3.05	3.90	4.72
Outer Conductor	3.25	4.15	4.96
Interlayer	3.49	4.28	5.10
Outer Shield	4.00	4.73	5.55
Jacket	4.60	5.20	6.20
<b>Mechanical</b>			
Min. Bending Radius Static	20mm	25mm	31mm
Min. Bending Radius Repeated	46mm	52mm	62mm
Weight	50g/m	60g/m	85g/m
Temperature range	-50 °C to +150 °C (cable only), -50 °C to +85 °C (cable assembly)		
<b>Electrical</b>			
Operating Frequency	DC-26.5 GHz	DC-18 GHz	DC-18 GHz
Impedance	50 Ω	50 Ω	50 Ω
Velocity of Propagation	76%	76%	76%
Shielding Effectiveness	>100 dB	>100 dB	>90 dB
Withstanding Voltage	1000 V	1500 V	2500 V
*Mechanical Phase Stability	<±6°@ DC-18GHz	<±6°	<±5°
**Amplitude Stability vs Shaking	<±0.2dB	<±0.2dB	<±0.15dB
Cable attenuation at 25 °C	see graph		
Power handling	see graph		
* Wrap the cable 360 degree around a mandrel whose diameter is ten times of cable outer diameter.			
** Shake the cable assembly at a rate of 90 times per minute at a height of 10 cm.			

## Attenuation (nominal values at +25 °C ambient temperature)

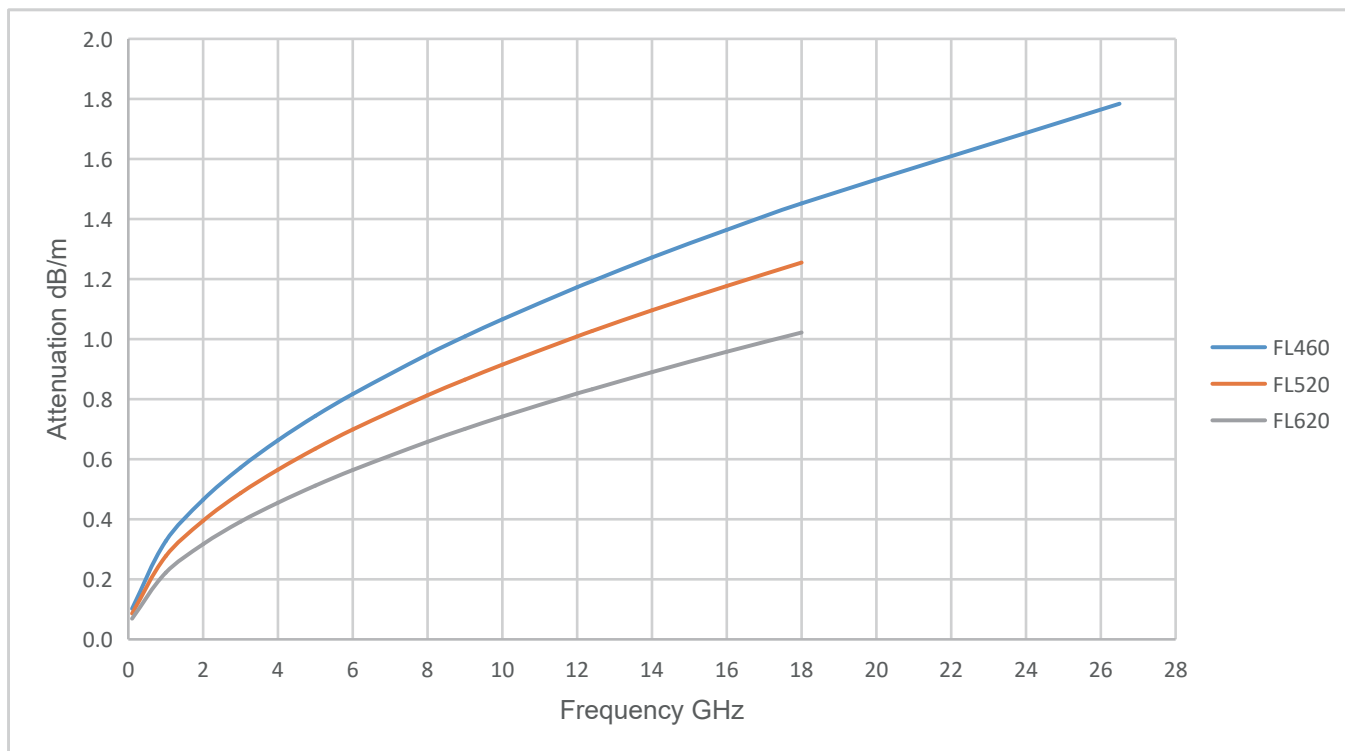

## Power handling (maximum values at 40 °C ambient temperature and sea level)

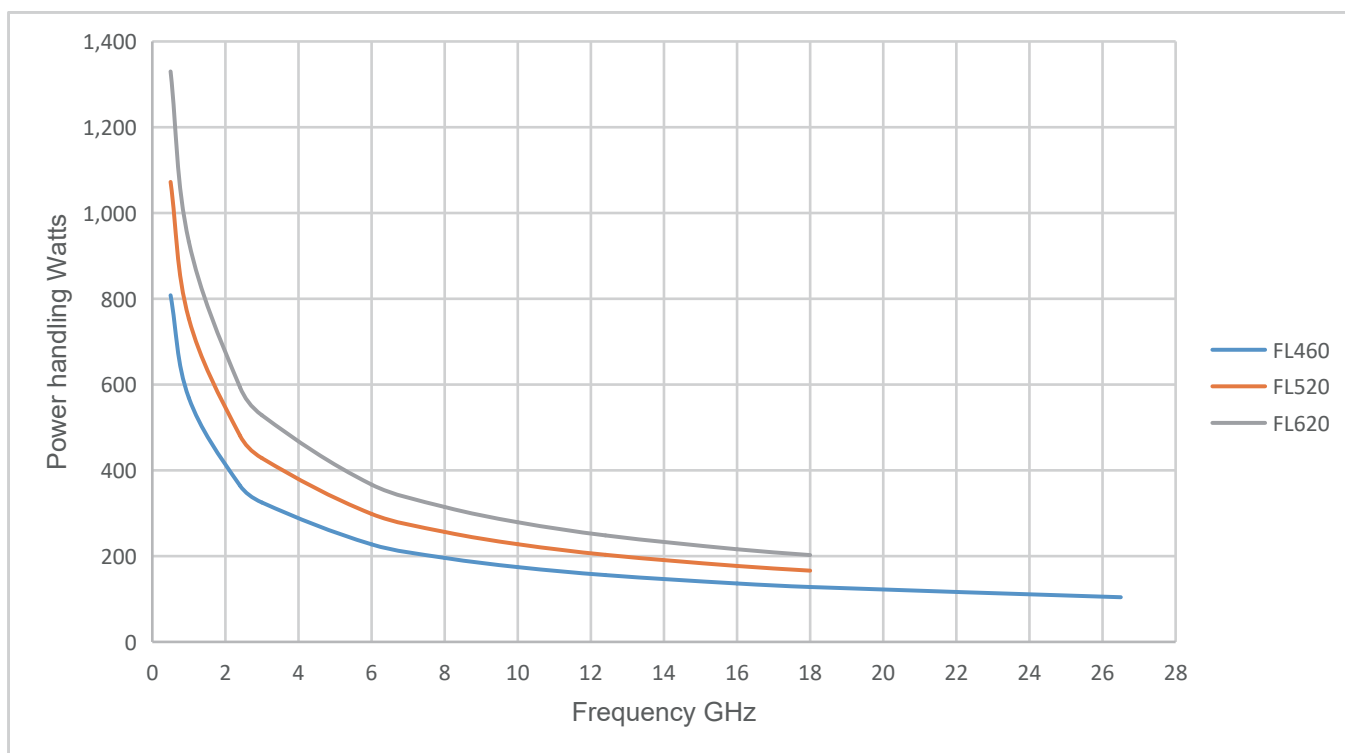

## Available Connectors

Cable P/N	Connectors	Gender	Orientation	Mounting	Max Freq (GHz)	VSWR Max
FL460	SMA	Male	Straight	Standard	18	1.25
	SMA	Female	Straight	Standard	18	1.3
	SMA	Male	Right Angle	Standard	18	1.35
	N	Male	Straight	Standard	18	1.3
	N	Male	Right Angle	Standard	18	1.35
	N	Female	Straight	Standard	18	1.35
	TNC	Male	Straight	Standard	18	1.3
	TNC	Male	Right Angle	Standard	18	1.35
FL520	SMA	Male	Straight	Standard	18	1.25
	N	Male	Straight	Standard	18	1.3
FL620	SMA	Male	Straight	Standard	18	1.25
	N	Male	Straight	Standard	18	1.3
	N	Female	Straight	Standard	18	1.35
	TNC	Male	Straight	Standard	18	1.35

Note: Other connectors available upon request.

## How to Order

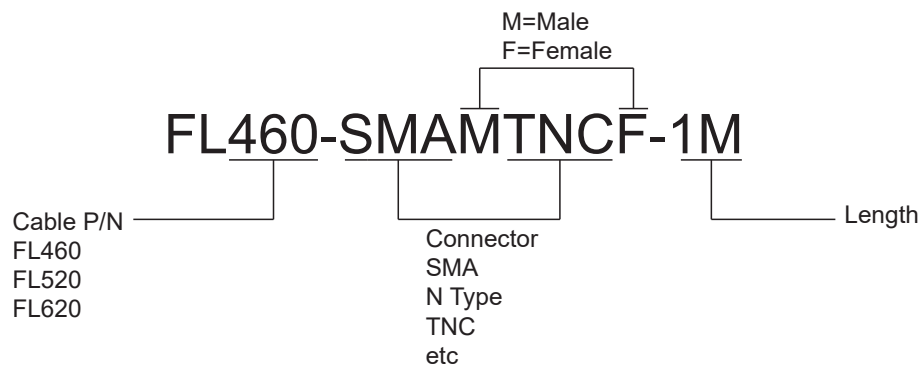

## Overview MB Series

### Tight Bend Triple-shielding Flexible Cable

MB series cable assemblies from RF ONE excel in their bendability from connector end, resulting from its unique cable structure and connector design. As alternatives to Minibend cables, MB series feature superior mechanical phase stability and robustness, operating max to 50 GHz. Now available in 047, 086, 141 cable sizes, with a complimentary connector range of SSMP, SMP, 2.4mm, 2.92mm and SMA.

### Features

- Allowing bend from connector end and can be repeatedly bent
- Alternative to Minibend
- High pull force with stainless steel wire braid
- Direct replacement of semi-rigid cables with lower loss, better phase stability
- Cost and space saving by eliminating use of right angle connectors and complicated bend configuration

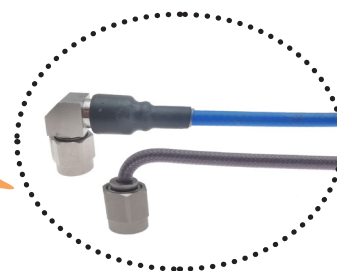
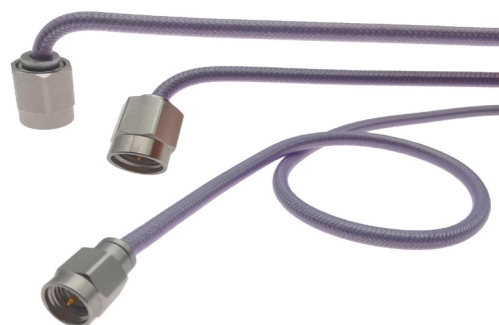

Replacing right angle connector

### Cable Data

Part Number	Outer Diameter(mm)	Static Bend Radius(mm)	Max Operation Freq(GHz)	Loss (dB/m @ max freq)	Avg Power (watts@ max freq)
MB200	2.0	8	40	7.3	7
MB250	2.5	10	50	6.4	35
MB250L	2.5	10	40	5.0	15
MB260L	2.6	11	50	4.8	13
MB360	3.6	8	26.5	2.2	63

### Cross Reference

RF ONE Model	Huber Suhner	ASTROLAB
MB200	Microbend	
MB250	Minibend	32081
MB260L	Minibend L, Minibend R	32024
MB360	Mini141	32022

## MB Series

### Tight Bend Triple-shielding Flexible Cable

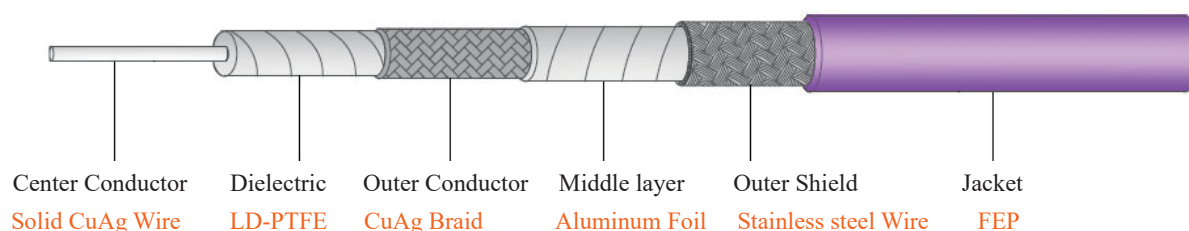

	MB200	MB250	MB250L	MB260L	MB360
<b>Cable Construction(Diameter in mm)</b>					
Center Conductor	0.36	0.51	0.51	0.56	0.91
Dielectric	1.14	1.65	1.55	1.70	2.72
Outer Conductor	1.30	1.82	1.71	1.85	2.79
Interlayer	1.45	1.90	1.81	1.98	2.95
Outer Shield	1.66	2.12	2.04	2.24	3.20
Jacket	2.00	2.50	2.50	2.64	3.61
<b>Mechanical</b>					
Min.Bending Radius Static	8mm	10mm	10mm	10.5mm	15 mm
Min. Bending Radius Repeated	20mm	25mm	25mm	26mm	36mm
Weight	12g/m	17g/m	16g/m	17g/m	31g/m
Temperature range	-50 C to +125 C (cable assembly)				
<b>Electrical</b>					
Operating Frequency	DC-40 GHz	DC-50 GHz	DC-40 GHz	DC-50 GHz	DC-26.5 GHz
Impedance	50 Ω	50 Ω	50 Ω	50 Ω	50 Ω
Velocity of Propagation	70%	70%	74%	75%	76%
Shielding Effectiveness	>90 dB	>90 dB	>90 dB	>90 dB	>90 dB
Withstanding Voltage	700 V	500 V	500 V	500 V	1000 V
*Mechanical Phase Stability	/	<±15°	<±8°	<±6° @ 40GHz <±8° @ 50GHz	<±6°
**Amplitude Stability vs Shaking	/	<±0.15dB	<±0.15dB	<±0.15dB	<±0.1dB
Cable attenuation at 25 C	see graph				
Power handling	see graph				
* Wrap the cable 360 degree around a mandrel whose diameter is ten times of cable outer diameter.					
** Shake the cable assembly at a rate of 90 times per minute at a height of 10 cm.					

## Attenuation (nominal values at +25 °C ambient temperature)

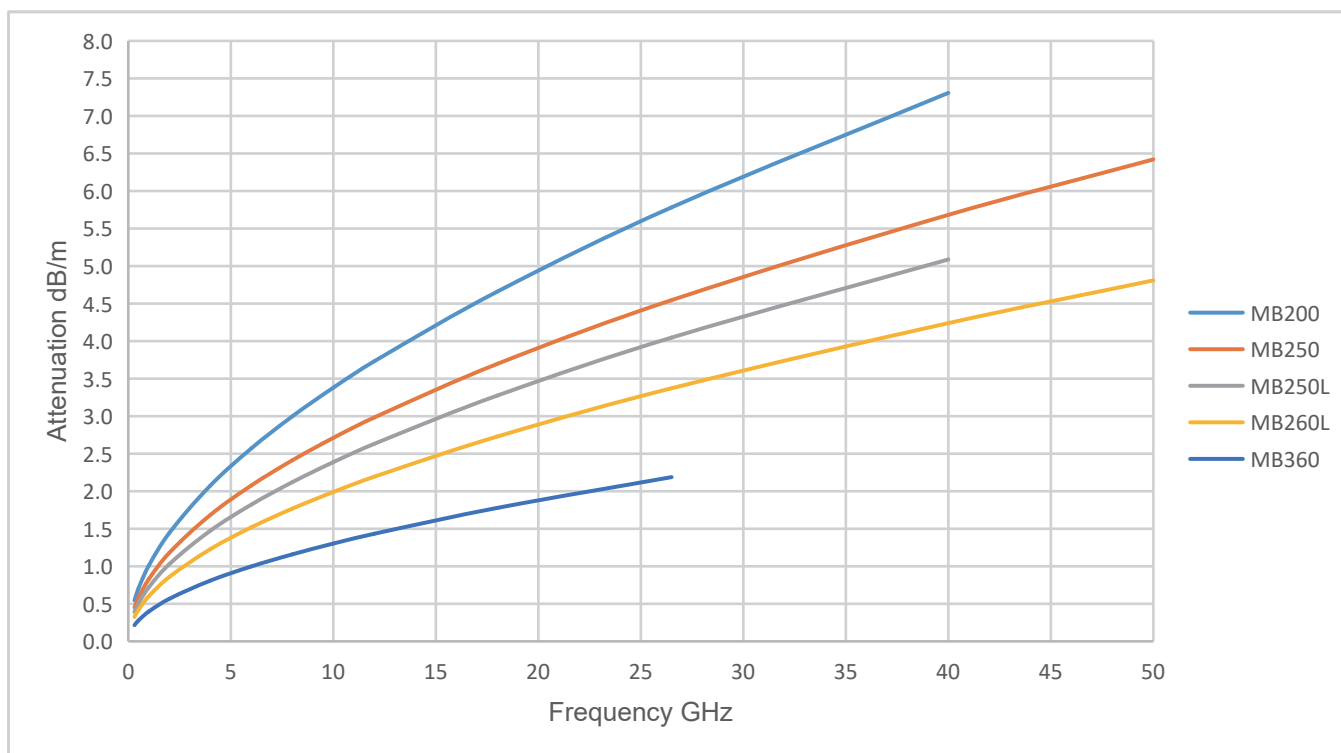

## Power handling (maximum values at 40 °C ambient temperature and sea level)

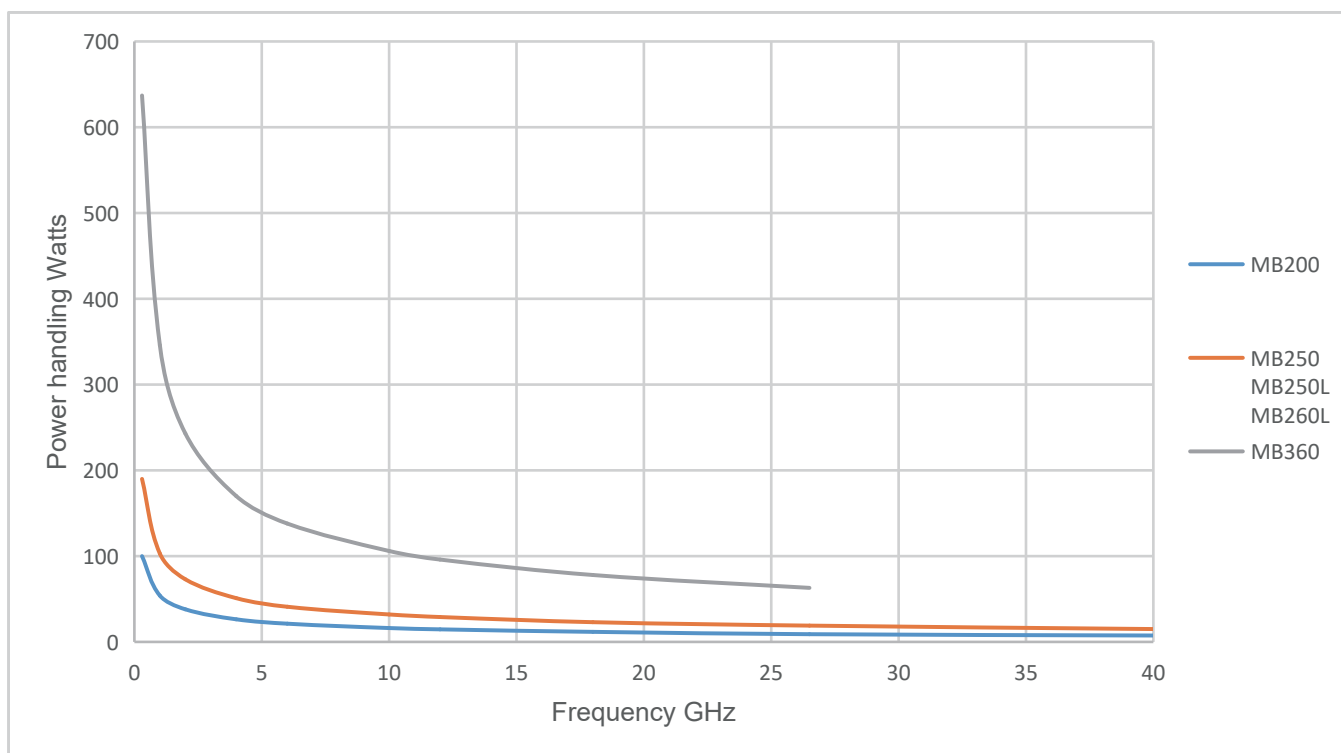

## Available Connectors

Cable P/N	Connectors	Gender	Orientation	Mounting	Max Freq (GHz)	VSWR Max
MB200	SMA	Male	Straight	Standard	26.5	1.35
	SMP	Female	Straight	Standard	26.5	1.35
	SSMP	Female	Straight	Standard	26.5	1.35
MB250	SMA	Male	Straight	Standard	26.5	1.35
	SMA	Female	Straight	Standard	26.5	1.35
	2.92mm	Male	Straight	Standard	40	1.4
	2.4mm	Male	Straight	Standard	50	1.45
MB250L	2.92mm	Male	Straight	Standard	40	1.4
MB260L	SMA	Male	Straight	Standard	26.5	1.35
	2.92mm	Male	Straight	Standard	40	1.4
	2.4mm	Male	Straight	Standard	50	1.45
	2.4mm	Female	Straight	Standard	50	1.45
MB360	SMA	Male	Straight	Standard	26.5	1.35

Note: Other connectors available upon request.

## How to Order

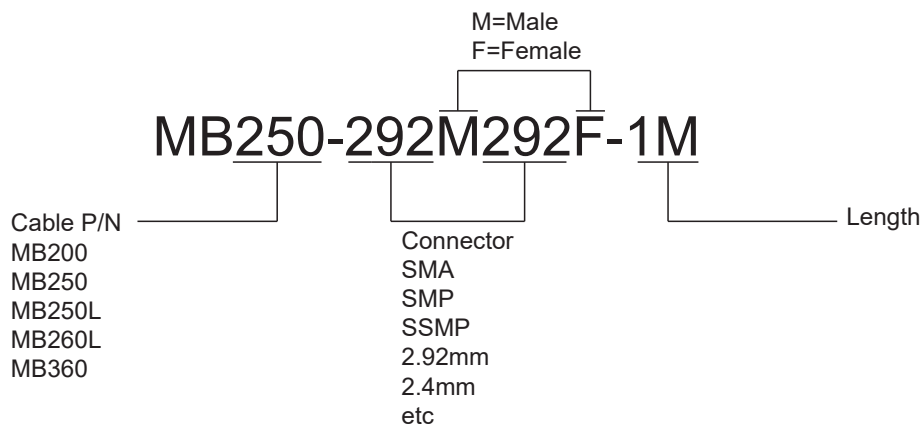

## Overview UF Series

### Ultra-Flexible Phase Stable Low Loss Cable

UF series cable assemblies from RF ONE feature super flexibility and mechanical phase stability with stranded SPC center conductor. UF360 works to 40GHz with unique PTFE wrapping jacket that enhances its flexibility while accomplishing operating temp up to 200°C . UF520 and UF450 work to 26.5GHz and 40GHz respectively, in PUR or FEP jacket. These cables are alternative to H+S Sucoflex, rugged armors available.

### Features

- Ultra-flexible with stranded inner conductor
- Excellent phase and amplitude stability over flex
- Durable design, long life time
- Rugged armors available
- Fast delivery for custom lengths

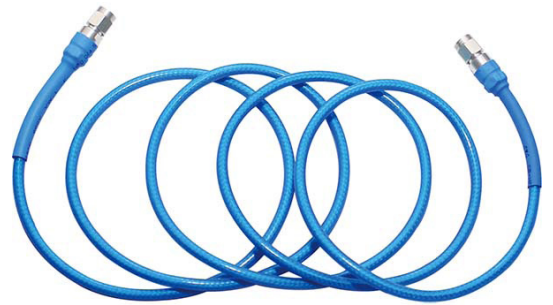

### Cable Data

Part Number	Outer Diameter(mm)	Jacket	Static Bend Radius(mm)	Max Operation Freq(GHz)	Loss(dB/m @ max freq)	Avg Power (watts@ max freq)
UF360	3.8	PTFE	18	40	3.1	54
UF450	4.5	PUR or FEP	22	40	3.0	57
UF520	5.2	PUR	18	26.5	2.5	23
UF550	5.5	FEP	22	26.5	1.6	114

### Cross Reference

RF ONE Model	Huber Suhner	
UF360		UF series from RF ONE features multi-stranded center conductor, available in PUR or PTFE jacket which make it highly flexible and ideal to use where frequent flexing is required and phase stability, low loss are uncompromised.
UF450		
UF520		
UF550	SUCOFLEX 126	



## UF Series

### Ultra-Flexible Phase Stable Low Loss Cable

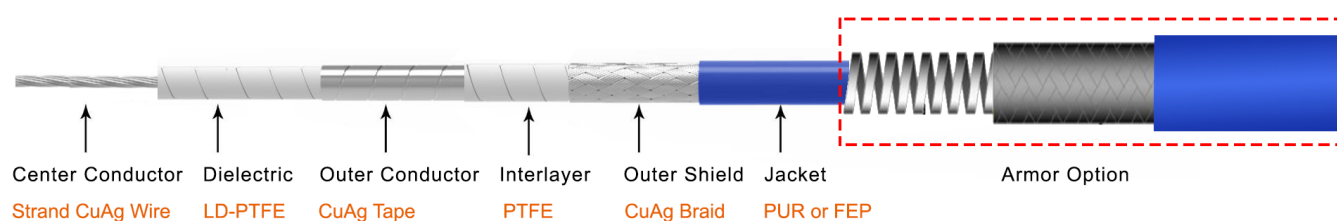

	UF360	UF450	UF520	UF550
<b>Cable Construction</b> (Diameter in mm)				
Center Conductor	0.91	0.91	1.02	1.44
Dielectric	2.50	2.65	3.03	1.60
Outer Conductor	2.66	2.80	3.22	4.20
Interlayer	2.90	3.08	3.47	4.55
Outer Shield	3.30	3.53	4.05	5.00
Jacket	3.80	4.50	5.20	5.50
*Armor Option	/	/	AU880	AU880
* Please refer to Page 33 for armor details.				
<b>Mechanical</b>				
Min.Bending Radius Static	18mm	22mm	18mm	22mm
Min. Bending Radius Repeated	36mm	45mm	50mm	55mm
Weight	36g/m	37g/m	55g/m	63g/m
Operating Temperature (Cable only)	-50 °C to +85 °C (PUR Jacket), -50 °C to +150 °C (FEP Jacket)			
<b>Electrical</b>				
Operating Frequency	DC-40 GHz	DC-40 GHz	DC-26.5 GHz	DC-26.5 GHz
Impedance	50 Ω	50 Ω	50 Ω	50 Ω
Velocity of Propagation	81%	76%	76%	83%
Shielding Effectiveness	>90 dB	>90 dB	>90 dB	>90 dB
Withstanding Voltage	1000 V	900 V	2000 V	1500 V
**Mechanical Phase Stability	<±5°	<±5°	<±5°	<±3° @18GHz <±7° @26.5GHz
***Amplitude Stability vs Shaking	<±0.15dB	<±0.15dB	<±0.1dB	<±0.2dB
Cable attenuation at 25 °C	see graph			
Power handling	see graph			
** Wrap the cable 360 degree around a mandrel whose diameter is ten times of cable outer diameter.				
*** Shake the cable assembly at a rate of 90 times per minute at a height of 10 cm.				

## Attenuation (nominal values at +25 °C ambient temperature)

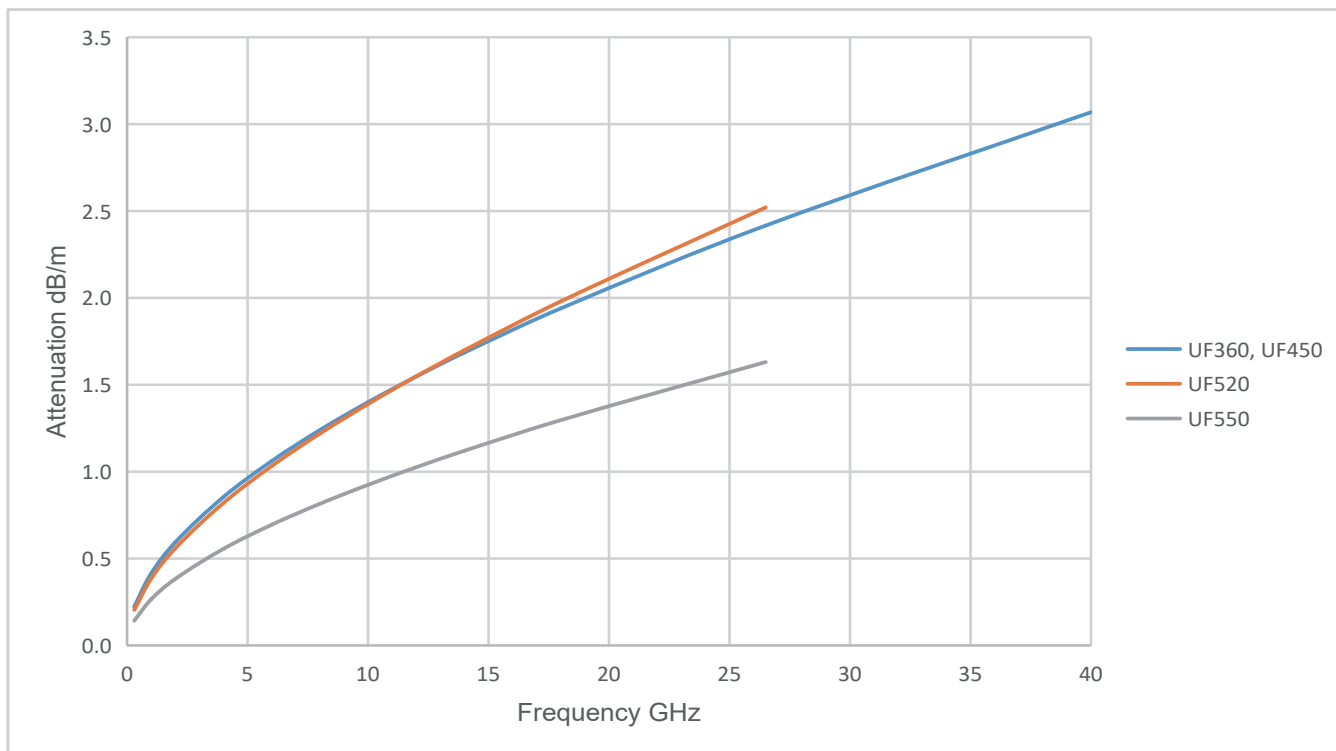

## Power handling (maximum values at 40 °C ambient temperature and sea level)

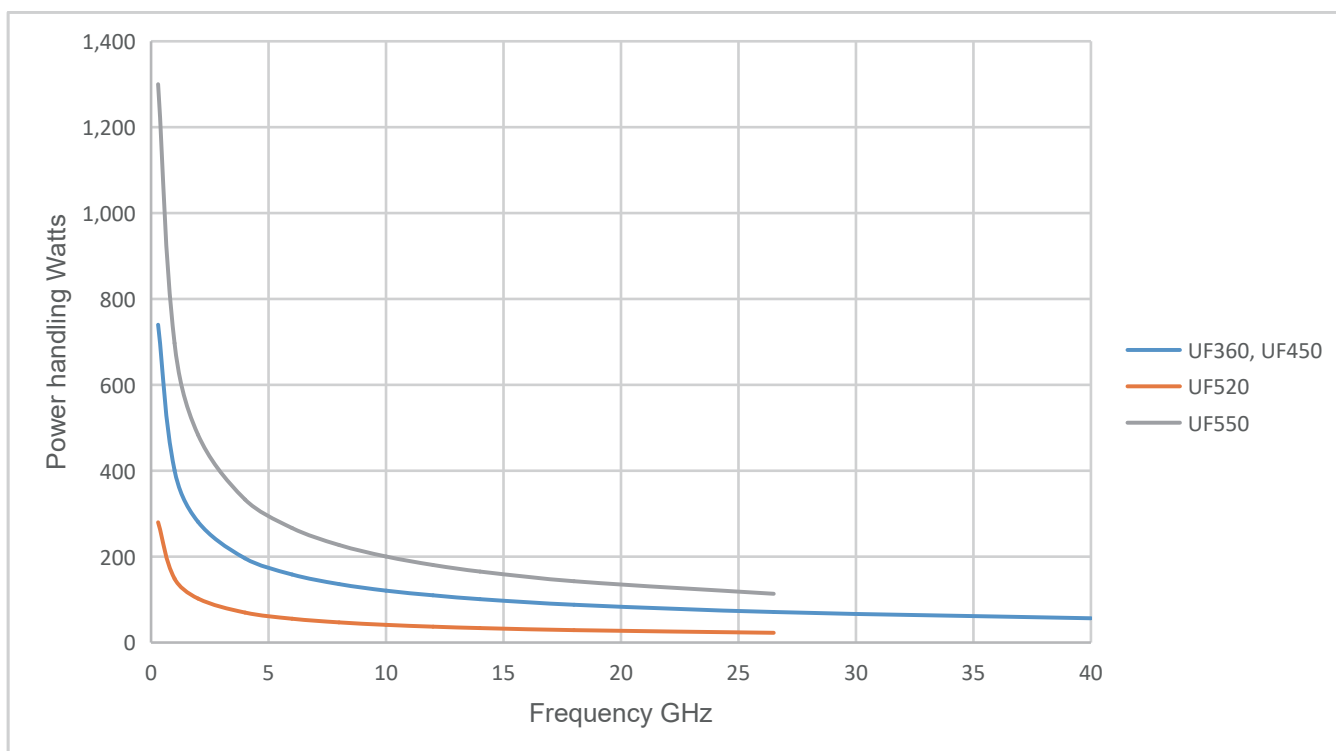

## Available Connectors

Cable P/N	Connectors	Gender	Orientation	Mounting	Max Freq (GHz)	VSWR Max
UF360	SMA	Male	Straight	Standard	26.5	1.3
	SMA	Male	Right Angle	Standard	18	1.35
	3.5mm	Male	Straight	Standard	33	1.3
	2.92mm	M/F	Straight	Standard	40	1.3
UF450	SMA	Male	Straight	Standard	26.5	1.25
	SMA	Female	Straight	Standard	26.5	1.3
	2.92mm	Male	Straight	Standard	40	1.3
UF520	TNC	Male	Straight	Standard	13.5	1.35
	N	Male	Straight	Standard	18	1.3
	N	Male	Right Angle	Standard	18	1.4
	SMA	Male	Straight	Standard	26.5	1.25
	SMA	Male	Right Angle	Standard	18	1.35
UF550	N	Male	Straight	Standard	18	1.3
	SMA	Male	Straight	Standard	26.5	1.3

Note: Other connectors available upon request.

## How to Order

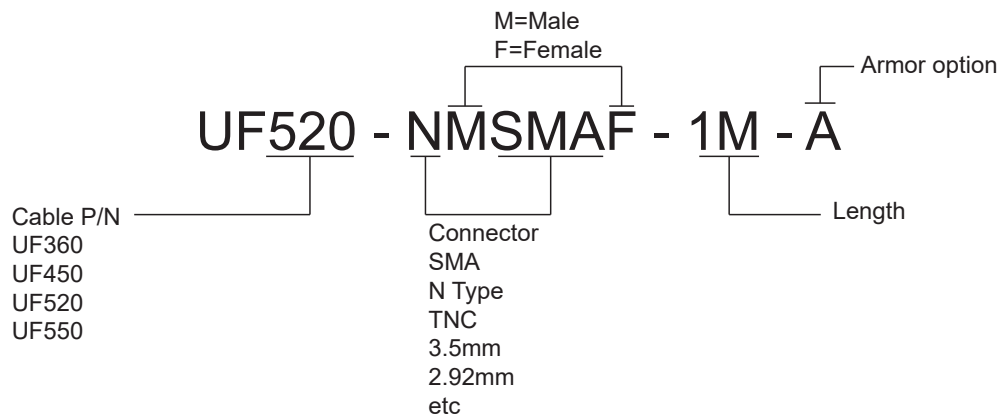

## Overview SP Series

### Low Loss Flexible Cable Replacing Semi-flexible Cable

SP series from RF ONE are low cost flexible cables as replacement for semi-flexible cables. Size for size, they offer lower insertion loss and better flexibility than the hand-formable cables. Available in 047, 086 and 141 sizes, they are ideal for high density interconnection use. Bulk cables are offered as well, allowing greater flexibility for end user in connector terminations.

### Features

- Superior flexible cable alternative to semi-flexible cables
- Up to 67 GHz, available in 047, 086 and 141 sizes
- Highly competitive pricing, from stock
- Each cable assembly delivered with test plot

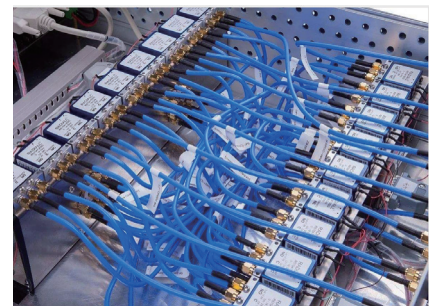

### Cable Data

Part Number	Outer Diameter(mm)	Static Bend Radius(mm)	Max Operation Freq(GHz)	Loss (dB/m @ max freq)	Avg Power (watts@ max freq)
SP160	1.6	6	67	11.9	4
SP280	2.8	14	40	4.4	16
SP400	4.0	20	26.5	2.8	36

### Cross Reference

RF ONE Model	Huber Suhner	TIMES	Harbour	HABIA
SP160				
SP280	Multiflex 86	TFlex-405	SS405	Multibend86
SP400	Multiflex 141	TFlex-402	SS402	Multibend141

## SP Series

### Low Loss Flexible Cable Replacing Semi-flexible Cable

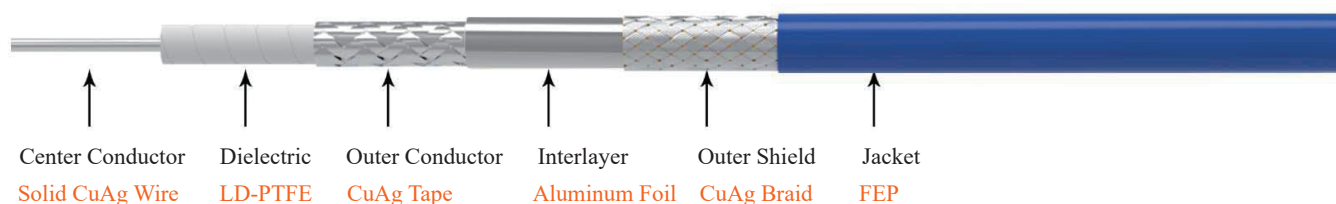

	SP160	SP280	SP400
<b>Cable Construction(Diameter in mm)</b>			
Center Conductor	0.29	0.51	0.91
Dielectric	0.94	1.63	3.00
Outer Conductor	1.14	1.79	3.20
Outer Shield	1.34	2.16	3.60
Jacket	1.60	2.80	4.00
<b>Mechanical</b>			
Min.Bending Radius Static	6mm	14mm	20mm
Min. Bending Radius Repeated	16mm	28mm	40mm
Weight	22g/m	22g/m	49g/m
Temperature range	-50℃ to +150℃ (cable only), -50℃ to +85℃ (cable assembly)		
<b>Electrical</b>			
Operating Frequency	DC-67 GHz	DC-40 GHz	DC-26.5 GHz
Impedance	50 Ω	50 Ω	50 Ω
Velocity of Propagation	70%	70%	70%
Shielding Effectiveness	>90 dB	>90 dB	>90 dB
Withstanding Voltage	500 V	1000 V	1000 V
Cable attenuation at 25℃	see graph		
Power handling	see graph		

## Attenuation (nominal values at +25 °C ambient temperature)

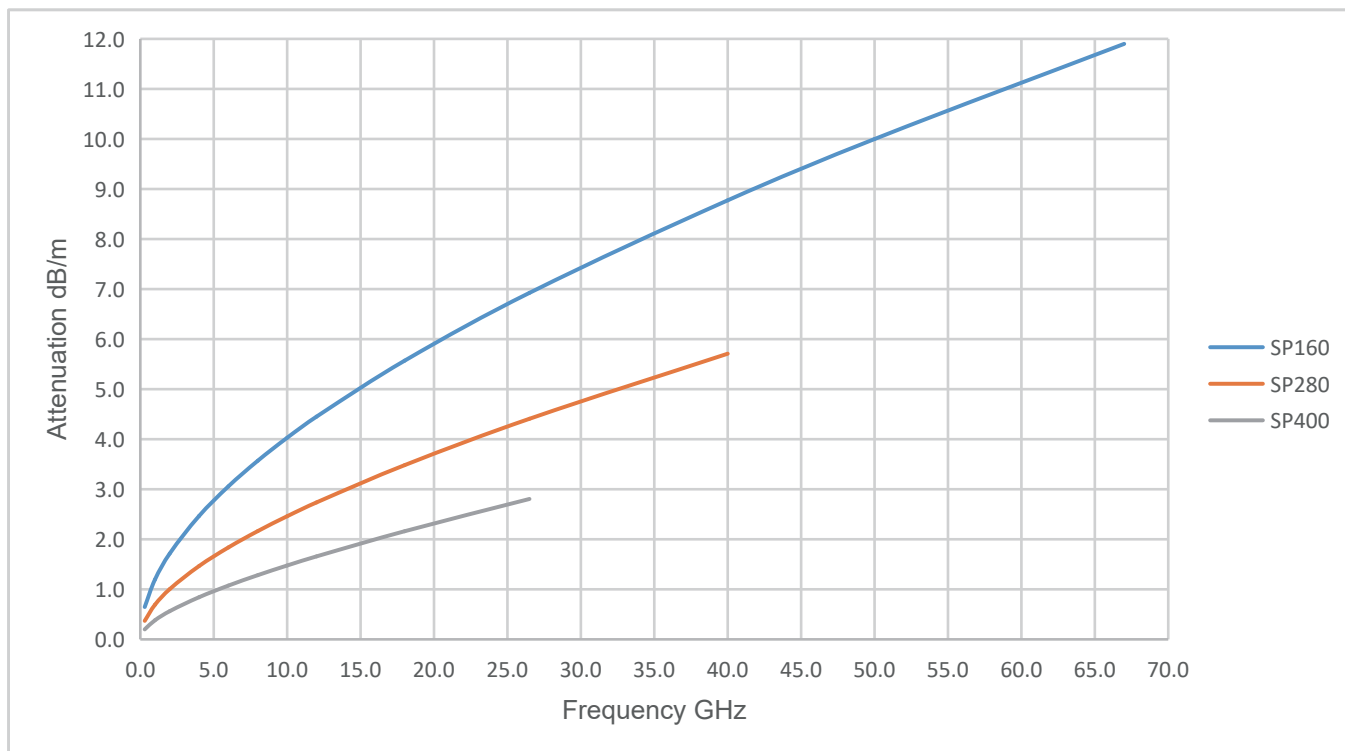

## Power handling (maximum values at 40 °C ambient temperature and sea level)

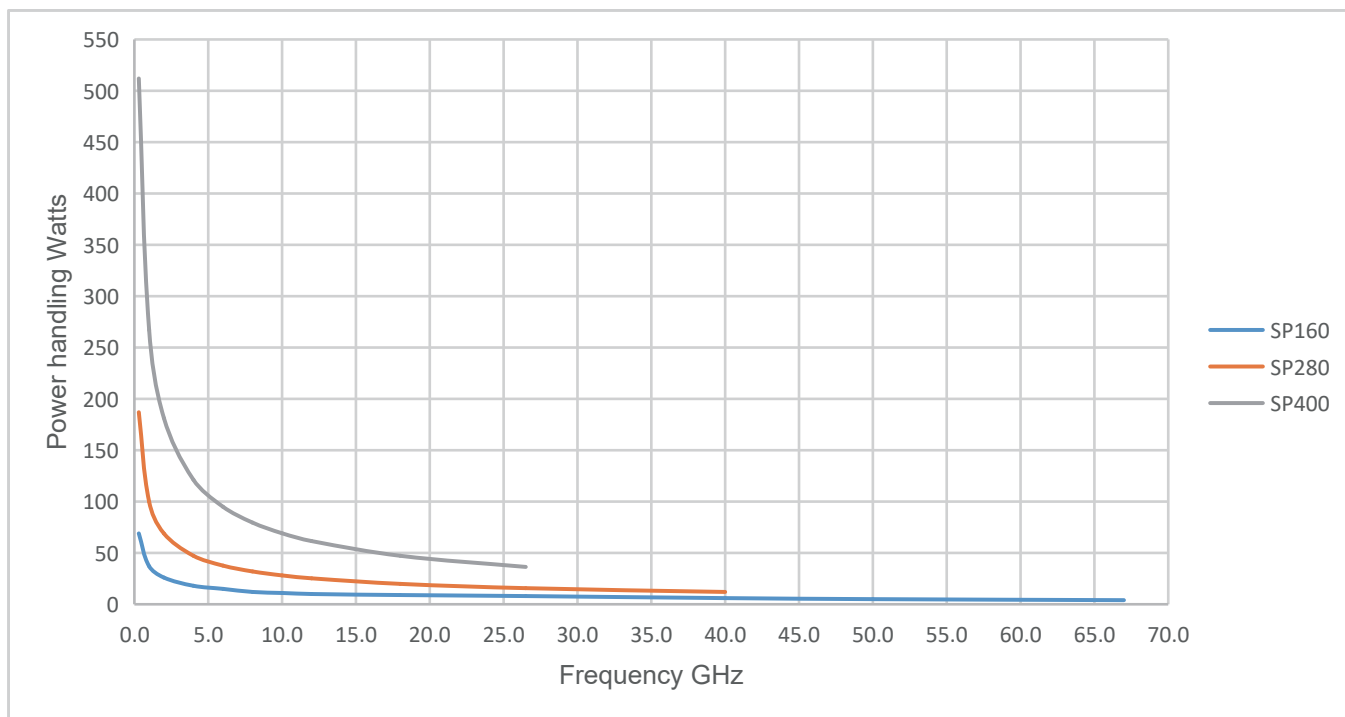

## Available Connectors

Cable P/N	Connectors	Gender	Orientation	Mounting	Max Freq (GHz)	VSWR Max
SP160	SMA	Male	Straight	Standard	18	1.2
	SMA	Female	Straight	Standard	18	1.25
	SMP	Female	Straight	Standard	18	1.35
	SSMP	Female	Straight	Standard	40	1.4
	SSMP	Male	Right Angle	Standard	40	1.6
	2.92	Male	Straight	Standard	40	1.3
	2.4	Male	Straight	Standard	50	1.35
	1.85	Male	Straight	Standard	67	1.4
SP280	N	Male	Straight	Standard	18	1.3
	SMA	Male	Straight	Standard	18	1.2
	2.92	Male	Straight	Standard	40	1.3
	2.92	Female	Straight	Standard	40	1.35
SP400	N	Male	Straight	Standard	18	1.3
	SMA	Male	Straight	Standard	26.5	1.25

Note: Other connectors available upon request.

## How to Order

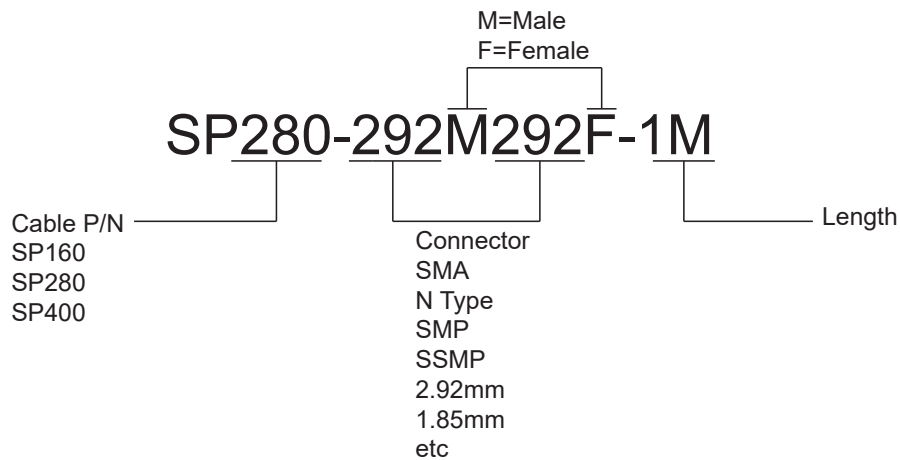

## Overview EL Series

### Economical Low Loss Flexible Cable

EL series cable assemblies from RF ONE are very affordable low loss flexible cables with max operating frequency options of 13.5GHz, 18GHz and 26.5GHz. Built from low density PTFE dielectric, these cables are well suited for high frequency signal transmission use when low loss is desired but phase stability is not highly critical.

### Features

- Attractive cost vs performance ratio
- Good amplitude stability vs flex and shaking
- Low Loss with low density PTFE dielectric



### Applications

- Ideal for interconnect of assembled systems
- Communication receivers and transmitters
- Low loss test accessory

### Cable Data

Part Number	Outer Diameter(mm)	Static Bend Radius(mm)	Max Operation Freq(GHz)	Loss (dB/m @ max freq)	Avg Power (watts@ max freq)
EL280	2.8	12	26.5	3.7	16
EL350	3.5	14	18	1.8	101
EL520	5.2	20	18	1.2	157
EL780	7.8	32	13.5	0.7	392



## EL Series

### Economical Low Loss Flexible Cable

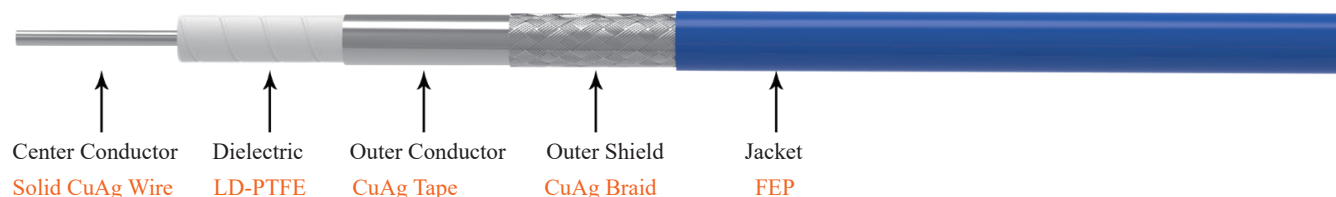

	EL280	EL350	EL520	EL780
<b>Cable Construction</b> (Diameter in mm)				
Center Conductor	0.56	0.94	1.45	2.3
Dielectric	1.67	2.75	4.30	6.6
Outer Conductor	1.83	2.80	4.38	6.7
Outer Shield	2.20	3.20	4.78	7.3
Jacket	2.80	3.50	5.20	7.8
<b>Mechanical</b>				
Min.Bending Radius Static	12mm	14mm	20mm	35mm
Min. Bending Radius Repeated	28mm	35mm	52mm	75mm
Weight	18g/m	29g/m	60g/m	110g/m
Temperature range	-50℃ to +150℃ (cable only), -50℃ to +85℃ (cable assembly)			
<b>Electrical</b>				
Operating Frequency	DC-26.5 GHz	DC-18 GHz	DC-18 GHz	DC-13.5 GHz
Impedance	50 Ω	50 Ω	50 Ω	50 Ω
Velocity of Propagation	76%	76%	76%	76%
Shielding Effectiveness	>90 dB	>90 dB	>90 dB	>90 dB
Withstanding Voltage	500 V	800 V	1500 V	2000 V
*Mechanical Phase Stability	<±10°	<±8°	<±6°@ DC-13.5GHz	<±6°
**Amplitude Stability vs Shaking	<±0.1dB	<±0.1dB	<±0.1dB	<±0.1dB
Cable attenuation at 25℃	see graph			
Power handling	see graph			
* Wrap the cable 360 degree around a mandrel whose diameter is ten times of cable outer diameter.				
** Shake the cable assembly at a rate of 90 times per minute at a height of 10 cm.				

## Attenuation (nominal values at +25 °C ambient temperature)

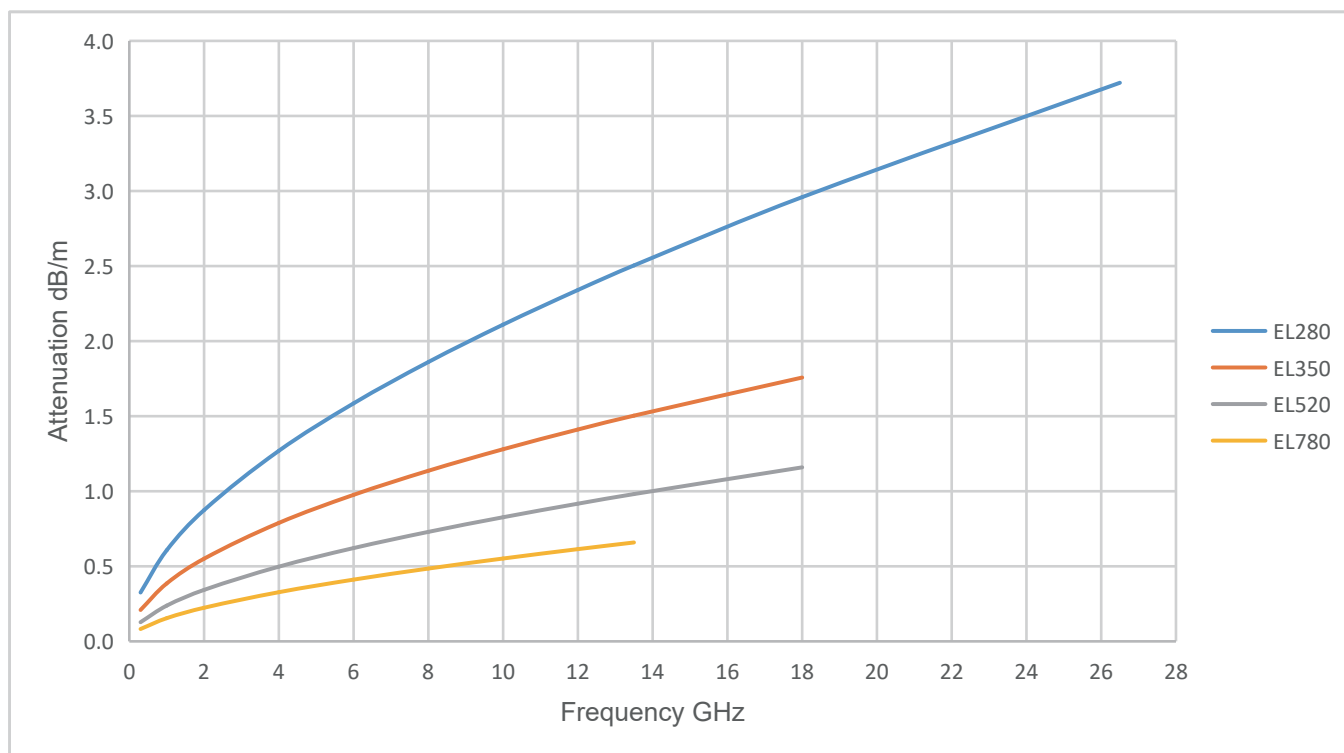

## Power handling (maximum values at 40 °C ambient temperature and sea level)

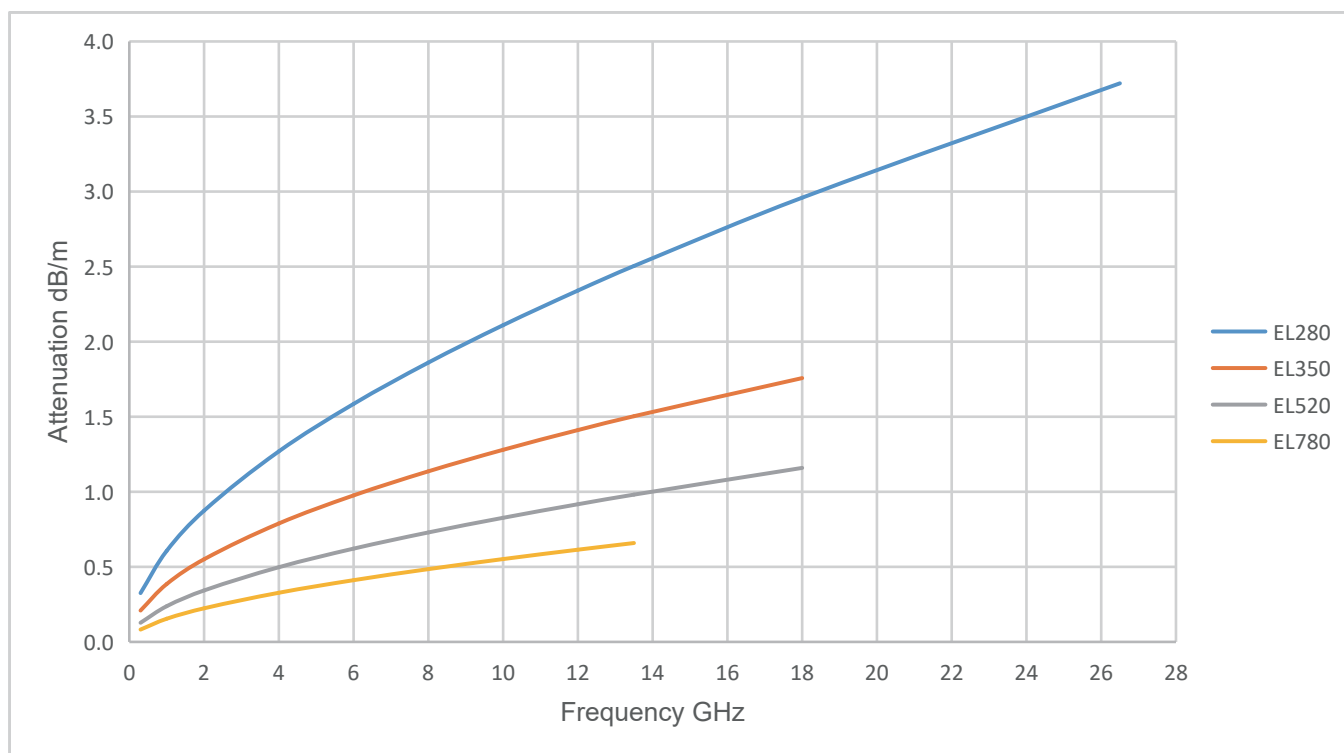

## Available Connectors

Cable P/N	Connectors	Gender	Orientation	Mounting	Max Freq (GHz)	VSWR Max
EL280	SMA	Male	Straight	Standard	26.5	1.25
	N	Male	Straight	Standard	18	1.3
EL350	SMA	Male	Straight	Standard	18	1.25
	N	Male	Straight	Standard	18	1.3
EL520	SMA	Male	Straight	Standard	18	1.35
	N	Male	Straight	Standard	13.5	1.3
	N	Male	Right Angle	Standard	13.5	1.35
	N	Female	Straight	Standard	13.5	1.35
	TNC	Male	Straight	Standard	13.5	1.35
EL780	SMA	Male	Straight	Standard	13.5	1.3
	SMA	Male	Right Angle	Standard	13.5	1.35
	N	Male	Straight	Standard	13.5	1.3
	N	Male	Right Angle	Standard	13.5	1.35
	N	Female	Straight	Standard	13.5	1.35
	TNC	Male	Straight	Standard	13.5	1.35

Note: Other connectors available upon request.

## How to Order

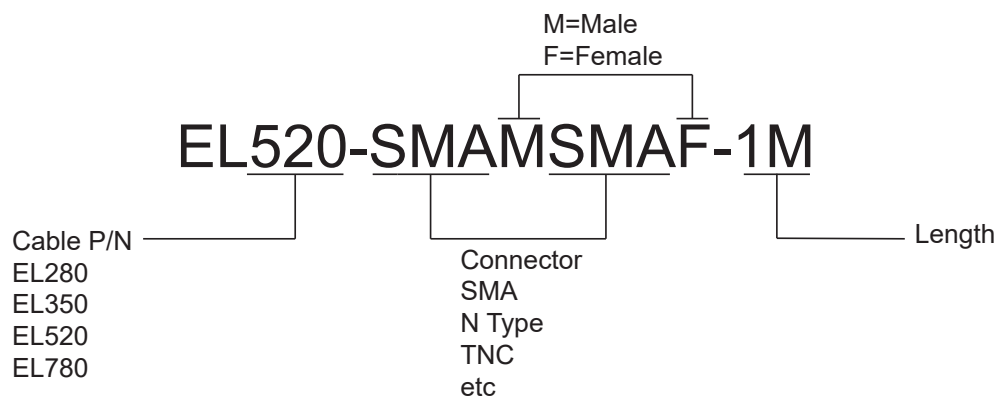

## Overview TP Series

### Temperature Phase Stable Cable



TP series from RF ONE is Low-loss and Phase-stable vs. temperature cables designed for phase-sensitive applications where minimal phase change over temperature is demanded.

Built from PFA dielectric, TP series cables offer outstanding 300 PPM (-40 to 60 °C) phase stability. PTFE, despite its excellent properties at high frequencies, shows a steep shift in phase in the temperature range of 15°C to 25°C. This phenomenon also known as PTFE knee could cause several problems such as detecting inefficiency, test measurement error etc. TP series cables are developed to solve this challenge.

### Features

- Excellent phase and insertion loss stability vs temperature
- No PTFE “Knee”
- Low loss operating to 40GHz
- Small bending radii and low profile for easy routing
- Available with 2.92mm, SMP, SSMP cable assemblies

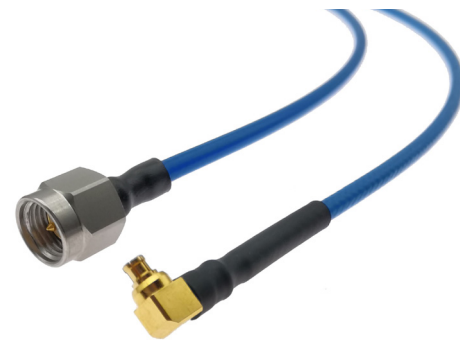

### Applications

- Phased array antennas
- Synthetic aperture radar satellites
- Network analyzer measurements

### Temperature Phase Stability (PFA versus PTFE)

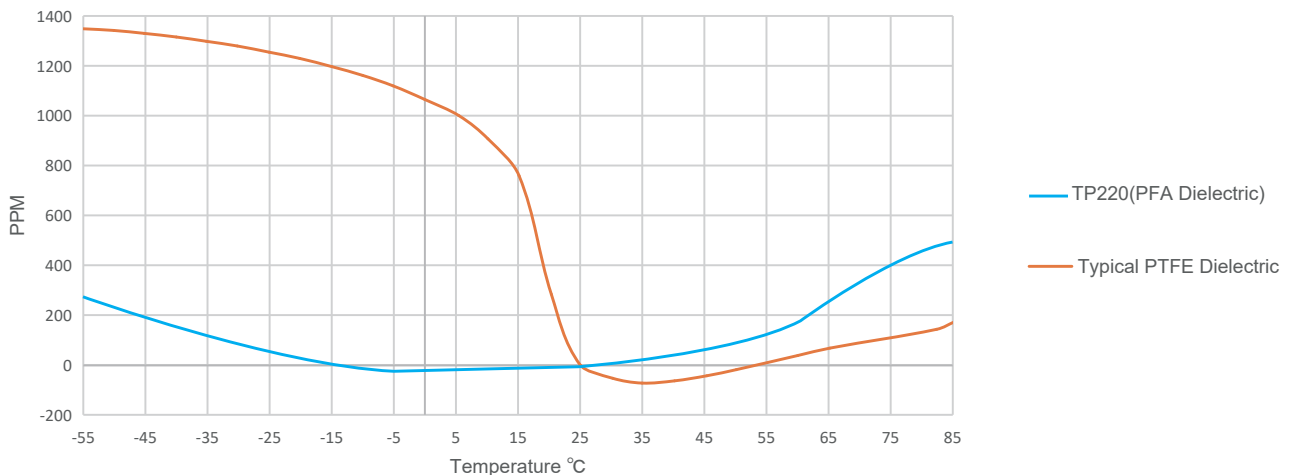

## TP Series

### Temperature Phase Stable Cable

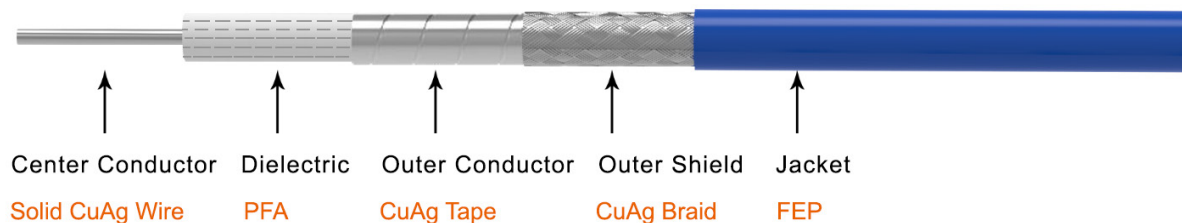

TP220	
<b>Cable Construction</b> (Diameter in mm)	
Center Conductor	0.51
Dielectric	1.40
Outer Conductor	1.56
Outer Shield	1.87
Jacket	2.20
<b>Mechanical</b>	
Min.Bending Radius Static	15mm
Min. Bending Radius Repeated	22mm
Weight	13g/m
Temperature range	-50℃ to +150℃ (cable only), -50℃ to +85℃ (cable assembly)
<b>Electrical</b>	
Operating Frequency	DC-40 GHz
Impedance	50 Ω
Velocity of Propagation	82%
Shielding Effectiveness	>90 dB
Withstanding Voltage	400 V
*Mechanical Phase Stability	<±6°
**Amplitude Stability vs Shaking	<±0.15dB
Temp Phase Stability (-40℃ to +60℃ )	<300ppm
Cable attenuation at 25℃	see graph
Power handling	see graph
* Wrap the cable 360 degree around a mandrel whose diameter is ten times of cable outer diameter.	
** Shake the cable assembly at a rate of 90 times per minute at a height of 10 cm.	

## Attenuation (nominal values at +25 °C ambient temperature)

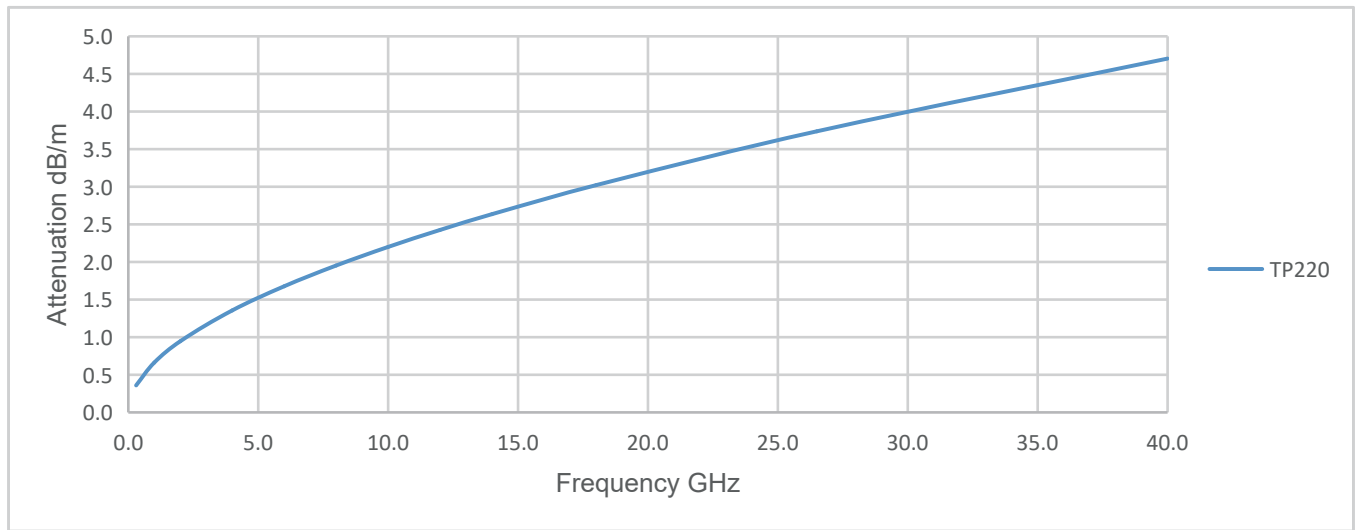

## Power handling (maximum values at 40 °C ambient temperature and sea level)

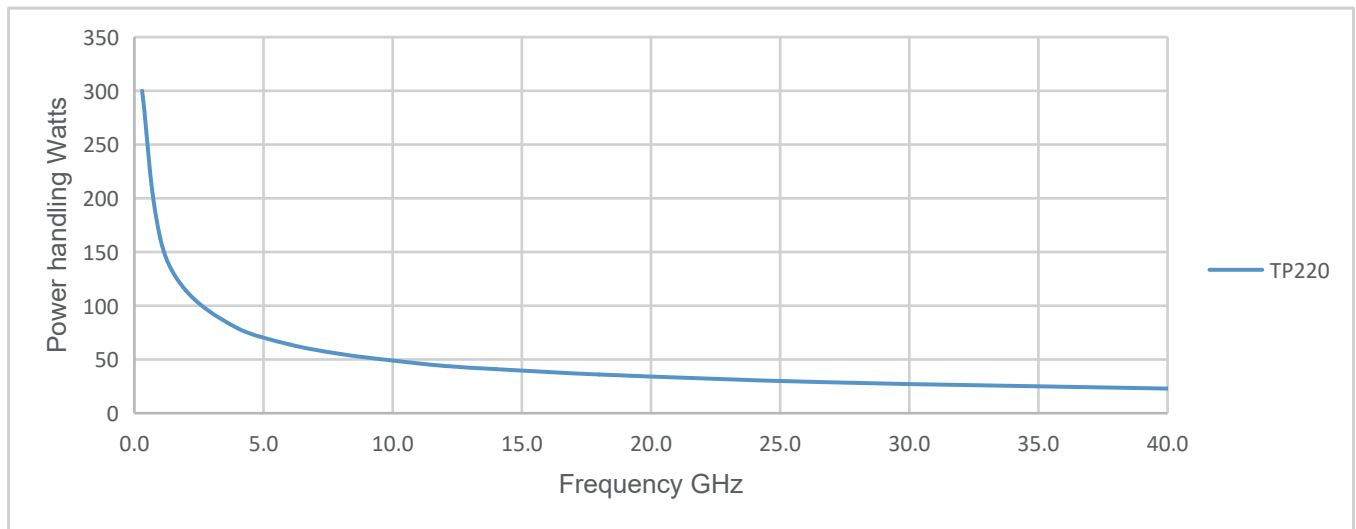

## Available Connectors



Cable P/N	Connectors	Gender	Orientation	Mounting	Max Freq (GHz)	VSWR Max
TP220	SMA	Male	Straight	Standard	26.5	1.3
	SMA	Female	Straight	Standard	18	1.3
	2.92mm	F/M	Straight	Standard	40	1.3
	SMP	Female	Straight	Standard	40	1.4
	SMP	Female	Right Angle	Standard	26.5	1.45
	SSMP	Female	Straight	Standard	40	1.4

Note: Other connectors available upon request.

## Armored Cable Assembly

### Introduction

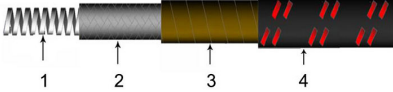
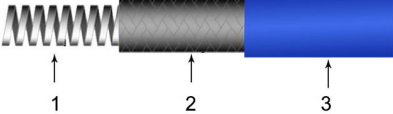
Armors are designed to withstand harsh environments and rough handling, significantly extending the life of cable assembly. RF ONE offers a number of rugged armor options to suit different applications and budgets.

Armor Code	Armor Illustration	Armor Construction	Features
AL		<ol style="list-style-type: none"> <li>Crush Resistance Layer: Stainless steel spiral</li> <li>Strengthening Layer: Silver plated copper braid</li> <li>Waterproof Layer: PTFE Binder</li> <li>Armor Jacket: Braiding PTFE</li> </ol>	<ul style="list-style-type: none"> <li>Operating temperature to +200 °C</li> <li>Providing four layers of protection</li> <li>Ultimate crush and abrasion resistance</li> <li>Long-term reliability with pull relief design</li> <li>Excellent flexibility</li> <li>Flexing life: 20,000 times</li> </ul>
AU		<ol style="list-style-type: none"> <li>Crush Resistance Layer: Stainless steel spiral</li> <li>Strengthening Layer: Silver plated copper braid</li> <li>Armor Jacket: PUR</li> </ol>	<ul style="list-style-type: none"> <li>Operating temperature limited to +85 °C</li> <li>High mechanical strength and ruggedness</li> <li>Highest flexibility</li> <li>Flexing life: 15,000 times</li> </ul>
SA		<ol style="list-style-type: none"> <li>Armor Jacket: Stainless steel interlock</li> </ol>	<ul style="list-style-type: none"> <li>Superior flexibility but heavy in weight</li> <li>Excellent crush resistance, withstanding outdoor or harsh environment</li> <li>Lower cost options</li> </ul>
PV		<ol style="list-style-type: none"> <li>Armor Jacket: PVC</li> </ol>	<ul style="list-style-type: none"> <li>Operating temperature limited to +75 °C</li> <li>Waterproof, resistant to most chemicals</li> <li>Lowest cost options</li> </ul>

## Armored Cable Assembly in AL Armor

### Features and Benefits

- Specially designed for Phase Stable Low Loss PL series cables
- Available in standard and low profile armor sizes
- Excellent phase and amplitude stability with flexure
- Precise and repeatable measurements
- Highly flexible and longer flex life
- Strain relief design and multi-layer armors against tension, torsion and abrasion

### Applications

- Test cables for VNA and RF/Microwave instruments
- Bench-top, RF production testing
- Wafer probing
- Automatic test equipment systems



### Standard AL Armored Cable Assemblies

Part Number	Freq Range (GHz)	VSWR Max	IL Max (dB)	Mechanical Phase Stability (Deg)	Amplitude Stability vs Shaking (dB)	Flex Life Min (cycles)	Connector
PL180P-1M1M-L-A	DC-110	1.45	14.4	<±12	<±0.2	20000	1.0mm
PL230P-185M185M-L-A	DC-67	1.4	7.1	<±7	<±0.15	20000	1.85mm
PL360P-24M24M-L-A	DC-50	1.35	4	<±5	<±0.1	20000	2.4mm
PL380P-292M292M-L-A	DC-40	1.3	2.8	<±5	<±0.1	20000	2.92mm
PL520P-SMAMSMAM-L-A	DC-26.5	1.3	1.7	<±5	<±0.1	20000	SMA
PL520P-NMNM-L-A	DC-18	1.25	1.5	<±5	<±0.1	20000	N Type

Notes:

1. Insertion loss refers to the loss of 1 meter cable assembly.
2. L in the Part Number refers to the length of cable assembly.
3. Custom length and other connector types as right angle, female etc are available.



## Anatomy of AL Armor

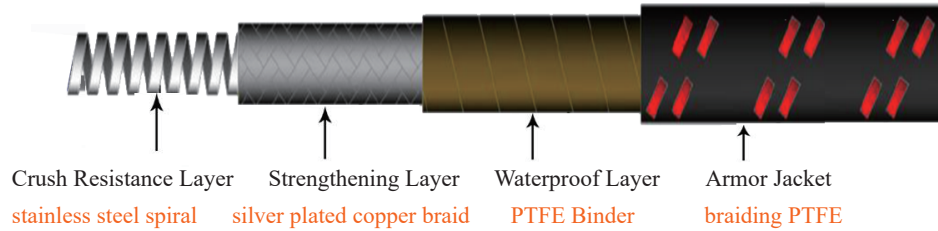

Armor P/N	AL380	AL500	AL640	AL780	AL1050
<b>Armor Size</b>					
Crush Resistance Layer I.D.	2.3mm	3.0mm	4.0mm	5.5mm	8.5mm
Crush Resistance Layer O.D.	2.8mm	3.6mm	4.8mm	6.4mm	9.3mm
Strengthening Layer	3.1mm	3.9mm	5.4mm	7.0mm	9.9mm
Waterproof Layer	3.2mm	4.1mm	5.4mm	7.1mm	10.0mm
Armor Jacket	3.8mm	4.7mm	6.4mm	7.8mm	10.9mm
<b>Mechanical</b>					
Weight	25g/m	42g/m	66g/m	93g/m	115g/m
Static Bend Radius	20mm	24mm	32mm	39mm	50mm
Crush Resistance	> 1000N/cm				
Temperature range	-55 °C to +200 °C				
Applicable Cables	PL180P	PL230P	PL230P PL360 PL360P PL380P PL390P	PL520P FL460 FL520	PL800

## Armored Cable Assembly in AU Armor

### Features and Benefits

- Operating temperature limited to +85°C
- High mechanical strength and ruggedness
- Highest flexibility
- Flexing life: 15,000 times



### Anatomy of AU Armor

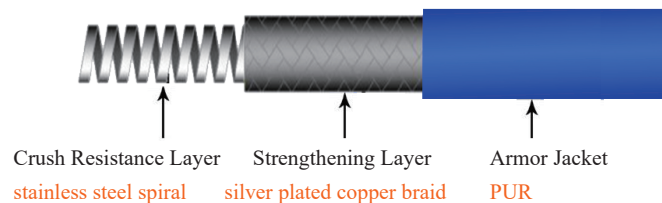

Armor P/N	AU660	AU880	AU1200
<b>Armor Size</b>			
Crush Resistance Layer I.D.	4.0mm	5.5mm	8.5mm
Crush Resistance Layer O.D.	4.8mm	6.5mm	9.3mm
Strengthening Layer	5.4mm	7.1mm	9.9mm
Armor Jacket	6.6mm	8.8mm	11.9mm
<b>Mechanical</b>			
Weight	65g/m	105g/m	150g/m
Static Bend Radius	33mm	44mm	60mm
Crush Resistance	800N/cm		
Temperature range	-55°C to +85°C		
Applicable Cables	PL360 PL360P PL380P PL390P	PL520P FL520 UF520 UF550	PL800

### Standard AU Armored Cable Assemblies

Part Number	Freq Range (GHz)	VSWR Max	IL Max (dB)	Mechanical Phase Stability (Deg)	Amplitude Stability vs Shaking (dB)	Flex Life Min (cycles)	Connector
UF520-SMAMSMAM-L-A	DC-26.5	1.25	3.1	<±5	<±0.1	15000	SMA
UF520-NMNM-L-A	DC-18	1.25	2.5	<±4	<±0.1	15000	N Type

Notes:

1. Insertion loss refers to the loss of 1 meter cable assembly.
2. L in the Part Number refers to the length of cable assembly.

## Phase Matched Cable Assemblies

Nowadays the microwave systems are in increased need for phase matched coaxial cable assemblies, with applications in Phased Array Radars, Multi-Beam Antenna Arrays, Multi-Channel Amplifiers and Environmental, Production or Lab Testing etc.

RF ONE provides two different versions of phase matching as shown in below diagram:

### Absolute Phase Matching and Relative Phase Matching

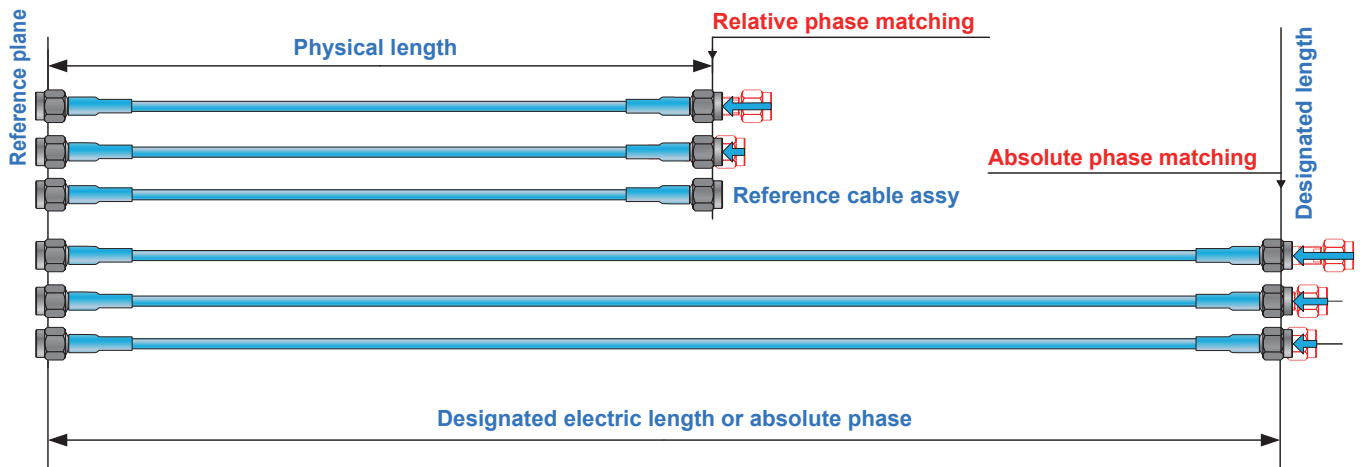

The match can be specified in **Electrical Length Match in Degrees** at a Specified Frequency (i.e.  $\pm 5^\circ$  @ 18 GHz) or in **Time Delay Match** (i.e.  $\pm 2$  ps). Please refer to Page 42 for detailed engineering information.

Thanks to our precisely controlled cable manufacturing process and highly skilled & experienced technicians, RF ONE is able to offer phase matched cable assemblies up to 110 GHz matched in a pair, or in a set to meet tolerance such as  $\pm 2$  ps to 67 GHz or  $\pm 4$  degree through 18 GHz.

Depending on the application, a variety of cable series available in phase match:

- **PL series**—Ultra-low Loss Phase and Amplitude Stable Flexible Cable
- **FL series**—Long Flex Life Triple-shielding Flexible Cable
- **EL series**—Economical Low Loss Flexible Cable
- **MB series**—Tight Bend Triple-shielding Flexible Cable
- **TP series**—Temperature Phase Stable Cable

When phase or delay matched cable assemblies are needed, please specify the below requirements:

- 1) Frequency of operation
- 2) Required phase match or delay match in  $\pm$  ps or in  $\pm$  degree @ x GHz
- 3) Quantity of cable assemblies in one set which are to be matched
- 4) Length of cable assemblies
- 5) Connectors of the assemblies in one set or pair

## Engineering Information

### Phase Stability Test with Flexure

Phase stability vs. flexure is a measure of the phase change as a result of cable flexing. The phase stability can be affected by the following factors:

- Cable material and construction
- Assembly technique
- Cable bend radius and bend angle
- The number of flexures

RF ONE performs the test of Phase Stability of Cable Assembly in below procedures.

#### 1. Initial Test

- 1) Connect the two ports of cable under test(CUT) with VNA, the cable is held in an initial unwrapped position and is measured in the phase and attenuation.
- 2) Normalize VNA in the phase.

#### 2. Test with cable wrapped 360 degree clockwise

- 1) Disconnect the CUT cable and wrap it 360 degree clockwise around a mandrel(diameter is ten times of cable outer diameter).
- 2) The CUT cable is held in such position for measurement, record the max phase and attenuation change over frequency range.

#### 3. Test with cable returned to original unwrapped position

- 1) Disconnect the CUT cable and return it to its original unwrapped position.
- 2) The CUT cable is held in such position for measurement, record the max phase change.
- 3) The worst-case phase variation in the above procedure is recorded as the phase stability value.

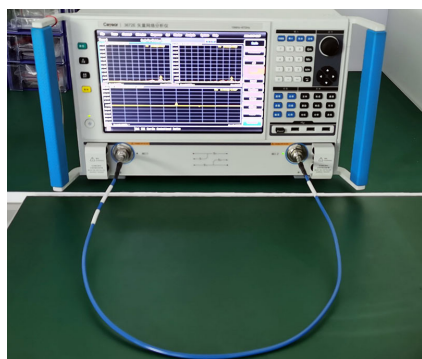

1. Initial Test

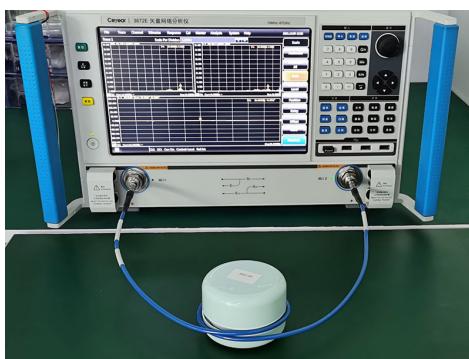

2. Wrapped 360 degree clockwise

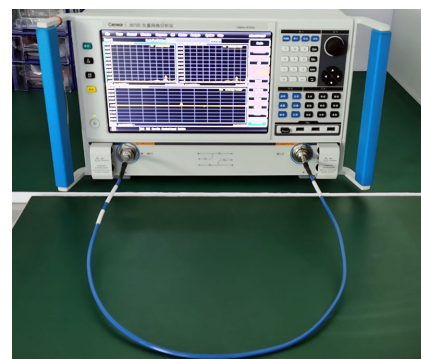

3. Returned to unwrapped position

## Engineering Information

### Test Data on Phase Stability with Flexure

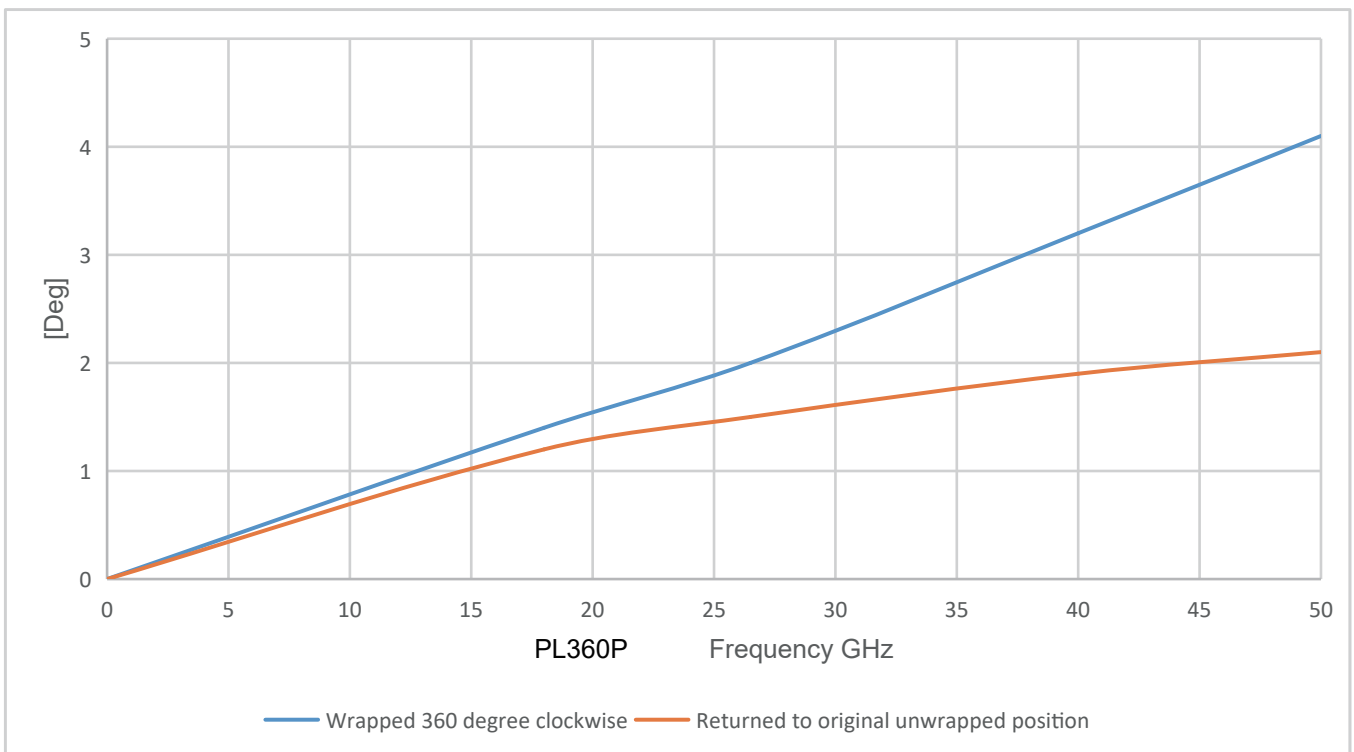
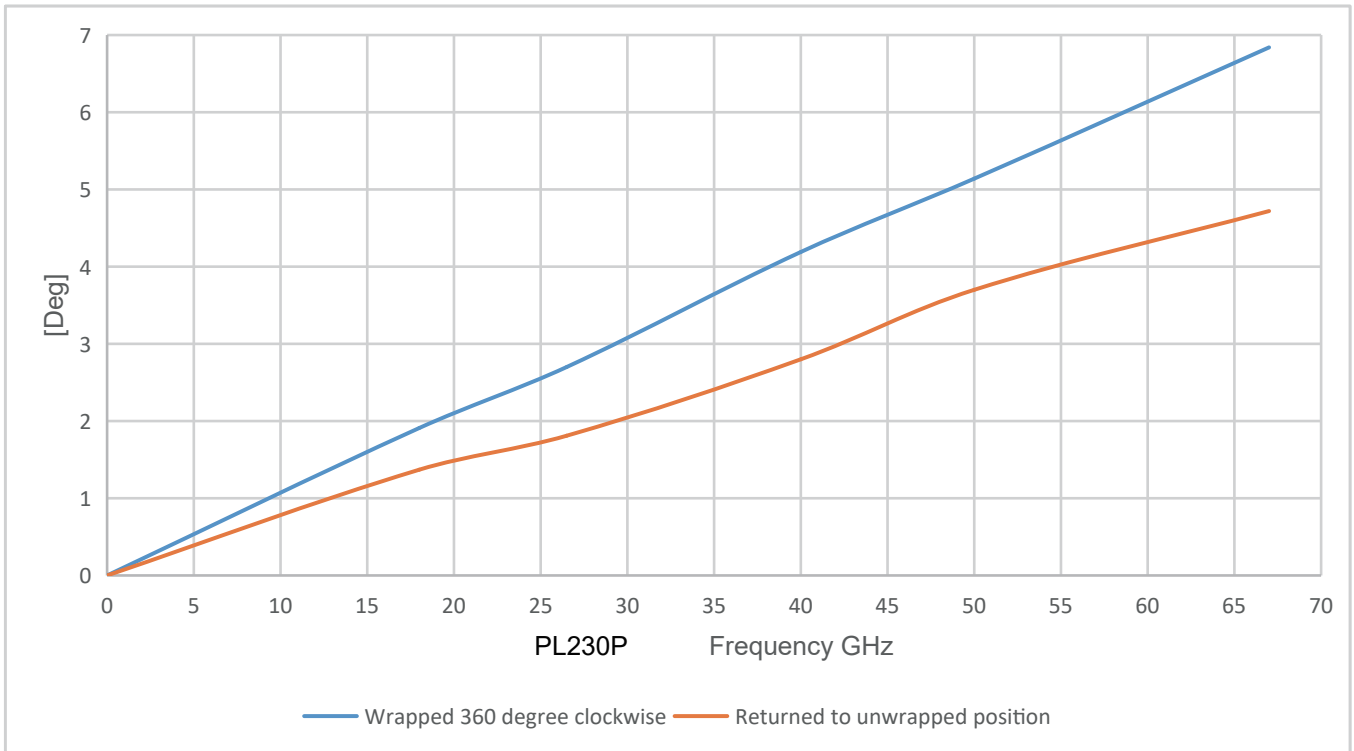

## Engineering Information

### Phase Stability Test over Temperature

Phase stability vs. temperature is a measure of the signal speed variation when the cable is exposed to different temperatures. The temperature variation will induce the change of the dielectric constant  $\epsilon_r$ , mechanical length, material character which will cause its phase variation. This variation can be unidirectional or multidirectional. The phase variation is characterized by the temperature coefficient of phase  $\eta_t$ , and the maximum variation of temperature coefficient of phase  $\Delta|\eta|_{\max}$

$$\eta_t = (\varphi_{25^\circ\text{C}} - \varphi_t) / \Phi_{25^\circ\text{C}} \qquad \Delta|\eta|_{\max} = |\eta_{\max} - \eta_{\min}|$$

where

- $\varphi_{25^\circ\text{C}}$  is the phase at temperature  $25^\circ\text{C}$  , in ( $^\circ$ )
- $\varphi_t$  is the phase at temperature  $t$ , in ( $^\circ$ )
- $\Phi_{25^\circ\text{C}}$  is the total phase at  $25^\circ\text{C}$  , in ( $^\circ$ )
- $\Delta|\eta|_{\max}$  is the maximum phase variation coefficient, in ppm

#### Test Equipment

A vector network analyzer (VNA), a temperature chamber.

#### Test Sample

The test cable shall be 3 m long and terminated with suitable connectors at each end.

#### Test Procedure

1. Test sample shall be put into a temperature chamber in loose coils with the diameter not less than 10 times the cable's minimum static bending radius. Adjust temperature of the chamber for 6 cycles and maintain at least 30 min at each limit temperature ( $85^\circ\text{C}$  and  $-55^\circ\text{C}$  ).
2. Set the temperature chamber to  $85^\circ\text{C}$  and maintain 10 min at least when it reaches the temperature. Connect Test sample with the VNA, test  $\Phi_{25^\circ\text{C}}$  and  $\varphi_{25^\circ\text{C}}$  .
3. Adjust the temperature of the chamber from the lowest temperature  $-55^\circ\text{C}$  to each higher temperature until to the maximum temperature  $85^\circ\text{C}$  , and record  $\varphi_t$  .
4. Use each  $\eta_t$  and temperature  $t$  draw the curve of phase variation with temperature at specified frequency  $f$ .

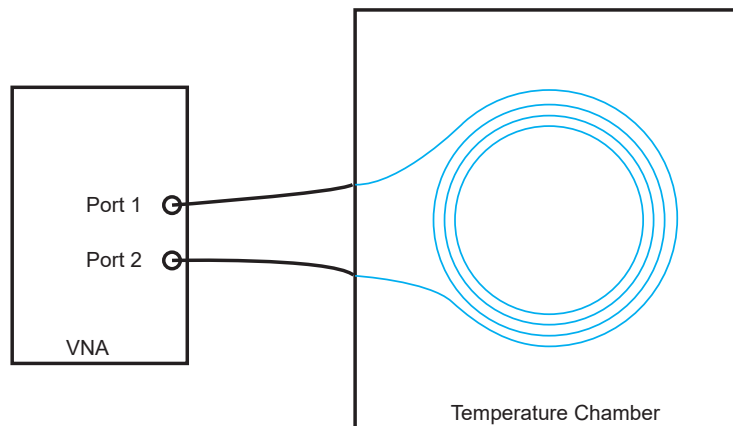

## Engineering Information

### Test Data on Phase Stability vs Temperature

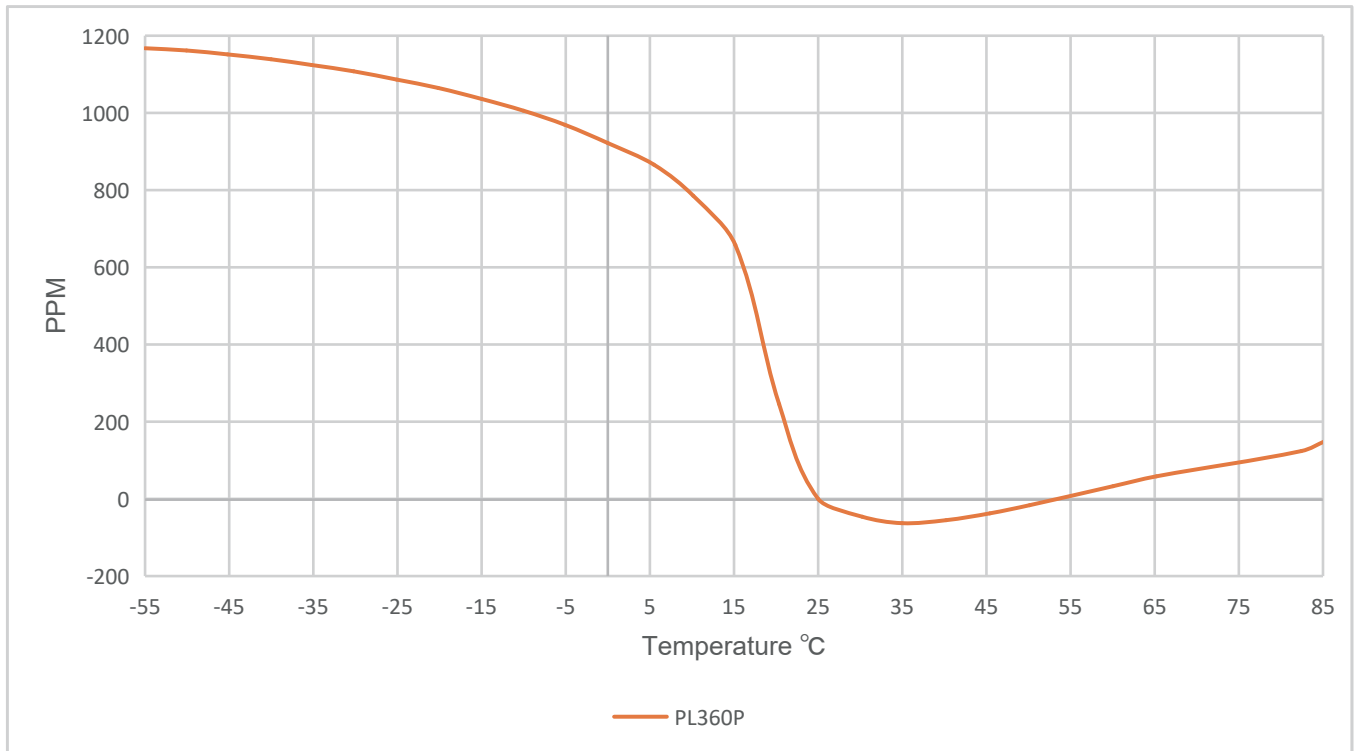
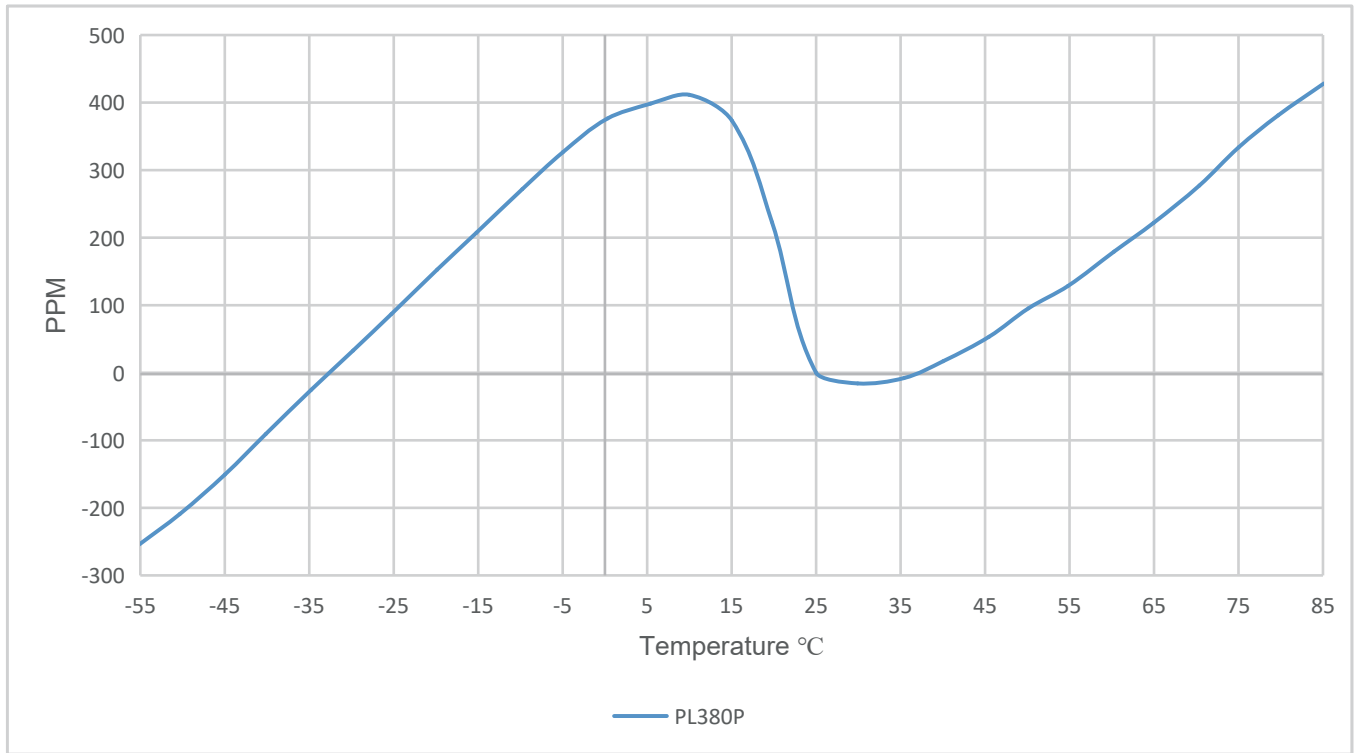

## Engineering Information

### Phase Matching of Cable Assemblies

Phase matching is a term generally used to describe two or more cable assemblies with the same electrical length. Normally two specifications are used for phase matched cables assemblies:

#### 1. Time Delay Match

Measure the time delay of each cable assembly by VNA, mark the time delay data typically at the middle point of the frequency range.

For example, a pair of 4 pcs cable assembly matched as DC-67GHz, time delay +/-2ps. Typical phase matching data as in below table.

Please refer to the test report example([www.rfone.cn/uploadfiles/pdf/Match-Electrical-Degrees.pdf](http://www.rfone.cn/uploadfiles/pdf/Match-Electrical-Degrees.pdf)) for more details.

S/N	01 Cable	02 Cable	03 Cable	04 Cable
Measured Delay	4048.8ps@33.5GHz	4048.9ps@33.5GHz	4047.7ps@33.5GHz	4049.3ps@33.5GHz
* Result	Max: 4049.3ps, Min:4047.7ps, Range:1.6ps(±0.8ps), Judgement: Pass			

Notes:

\* When the range of min & max data is within the phase match limit, it is judged Pass.

#### 2. Electrical Length Match in Degrees at a Specified Frequency

Measure the phase of each cable assembly by VNA across the required frequency range.

For example, a pair of 4 pcs cable assembly matched as DC-26.5GHz, +/-5 degree. Typical phase matching data as in below table.

Please refer to the test report example([www.rfone.cn/uploadfiles/pdf/Match-Electrical-Degrees.pdf](http://www.rfone.cn/uploadfiles/pdf/Match-Electrical-Degrees.pdf)) for more details.

S/N	01 Cable	02 Cable	03 Cable	04 Cable
* Measured Phase	0 degree	0.9 degree	2.0 degree	-1.1 degree
** Result	Max: 2.0 degree, Min:-1.1 degree, Range:3.1 degree(±1.6 degree), Judgement: Pass			

Notes:

\* Using S/N 001 as reference cable, phase of which is normalized on VNA. Measuring the phase for each of the rest cables.

\*\* When the range of min & max data is within the phase match limit, it is judged Pass.



## Engineering Information

### Typical Cable Structure

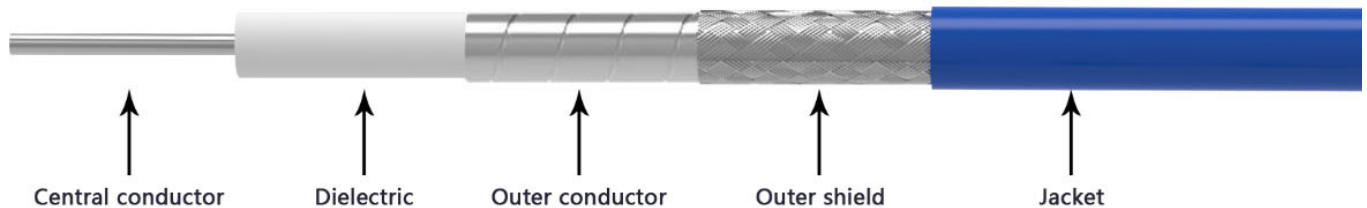

#### Center Conductor(Silver Plated Copper)

1. With equal size, solid center conductor cables tend to be more amplitude stable with flexing, stranded center conductor cables tend to be more phase stable with flexing.
2. Stranded center conductor cable is more flexible and endurable than solid center conductor cables under repeated bending.
3. With the same structure, material and processing, cables with thicker diameter center conductor features better attenuation and higher power handling than cables with thinner diameter center conductor.

#### Dielectric

A microporous low density PTFE dielectric cable will typically have better phase stability, lower loss and higher temperature handling than a solid PTFE or foamed FEP dielectric cable.

#### Outer Conductor

- Outer conductor in silver plated copper braiding features low loss, long flex life.
- Outer conductor in silver plated copper taping features ultra low loss, phase and amplitude stability
- Outer conductor in aluminum foil features lower cost, low loss.

#### Shielding

Silver plated copper wire braiding contributes to mechanical strength and additional RF shielding.

#### Jacket

- FEP jacket is high temperate and chemical resistant, operating -65 to 200℃ .
- PUR jacket is super flexible, operating to 85℃ only.
- PTFE jacket is very flexible, operating to 250℃ .

## Engineering Information

### General Assembly Information

#### Length definition

1. For straight connectors, the assembly length is measured from one connector end to the other connector end, for right angle connectors, use the pin center-line as shown in below drawing.
2. For non-phase matched cable assemblies, standard length tolerance is  $\pm 1.5\%$  for cables over 50 cm. For cables less than 50 cm, length tolerance is  $\pm 5\text{mm}$ .

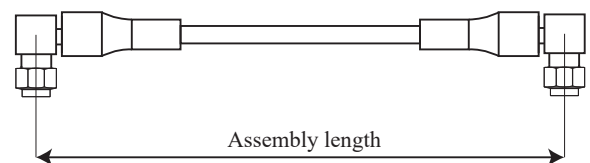
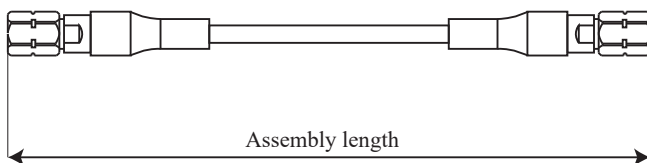

#### Care and handling instructions

1. Avoid kinking cables when straightening from a coil or reel.
2. Choose the installation routing using the largest bend radius possible. Small bend radius may affect electrical performance. Exceeding the specified limits during the installation process could cause a permanent degradation.
3. Avoid twisting microwave cable assemblies. Torsion of this type of assembly can alter the relative diameters of cable layers and affects the electrical characteristics.
4. When mating connectors with a screwed interface always hold the connector bodies and turn only the coupling nut. This avoids twisting the cable and ensures minimum wear on the connector pins.
5. Do not exceed the specified torque. Recommended torque value for S/Steel SMA and 2.92mm connector installation is 8 in lbs.

#### Warranty

All RF ONE cable assemblies have a limited 4-6 months warranty subject to RF ONE review. We will repair or replace the cable assemblies at its option if the cable assemblies fail within four-six months of shipment. This guarantee excludes damage from misuse or abuse.

## Frequently Asked Questions

### Does RF ONE offer cable assembly from stock?

Our standard raw cables and commonly used connectors(1.85mm/2.4mm/3.5mm/2.92mm/SMA/SMP/Type N) are in stock, cable assembly lead time is typically 1 week for any lengths. No MOQ.

### Can RF ONE provide raw cables and cable connectors besides cable assembly?

Yes, apart from cable assemblies, we are happy to sell either bulk cables or cable connectors to suit each customer's needs.

### How to choose a cable assembly properly?

1. RF ONE has uploaded raw cable data sheets on our website, from which you can check the cable diameter, frequency range and electrical performance etc.
2. If you are not sure which cable is fitting, check our Cable RFQ Form ([www.rfone.cn/uploadfiles/pdf/Cable-RFQ-Form.pdf](http://www.rfone.cn/uploadfiles/pdf/Cable-RFQ-Form.pdf))and consult with our sales representative.
3. Upon deciding on the raw cable P/N, connectors, length, RF ONE will create a specific data sheet for your reviewing.

### How to calculate the insertion loss of cable assembly?

1. Check our raw cable data sheets where you can find the typical attenuation data for 1 meter raw cable over full operating frequency range. Max attenuation is 1.1 times of typical attenuation. For 0.5 meter, dividing 2 by using the insertion loss of 1 meter.
2. Insertion loss per straight connector is estimated as  $0.04\text{dB} \times \text{SQRT Freq}(\text{GHz})$ . Insertion loss per right angle connector is estimated as  $0.08 \text{ dB} \times \text{SQRT Freq}(\text{GHz})$ .
3. The whole cable assembly loss is a combination of raw cable loss plus the loss of two connectors.

### Can RF ONE provide phase matched cable assembly?

Yes, RF ONE offers phase matching for PL series, EL series and other cable series. Please refer to page 37 for phase-matched cable assemblies.

### Can RF ONE provide custom cable assembly?

Yes, we are capable of building customized cable assembly in below but not limited to these aspects:

1. Custom length. For example even it is only 6cm including two connectors.
2. Custom connectors. For example one end is N female with 4 hole flange, the other end is stainless steel right angle SMA male.
3. Specially strengthened heat shrink boot to better protect the neck point.
4. Jacket or armor with capability of waterproof, crush resistance, corrosion resistance.
5. Microwave flexible cables with ultra low insertion loss, for example, 40GHz attenuation less than 2.2dB for 1 meter.

### What is RF ONE's cable RF shielding effectiveness?

Most of our flexible cables have  $-90 \text{ dB}$  minimum shielding from 1 to 18GHz. However, cable assembly shielding effectiveness can be limited by the connector design.

### What is RF ONE's cable characteristic impedance?

Our standard cable characteristic impedance is  $50 \text{ ohm} \pm 2 \text{ ohm}$ .



## **RF ONE Electronics**

**Add:** Suite 401, Bldg 1, Mingliang Technology Park,  
Zhuguang North Rd 88, Nanshan, Shenzhen, China

**Tel:** 86-755-86705630 86-755-27757880

**Web:** [www.rfone.cn](http://www.rfone.cn) [www.rfone.com.cn](http://www.rfone.com.cn)

**E-mail:** [sales@rfone.cn](mailto:sales@rfone.cn)



Download Catalog