

PRODUCT DATA SHEET

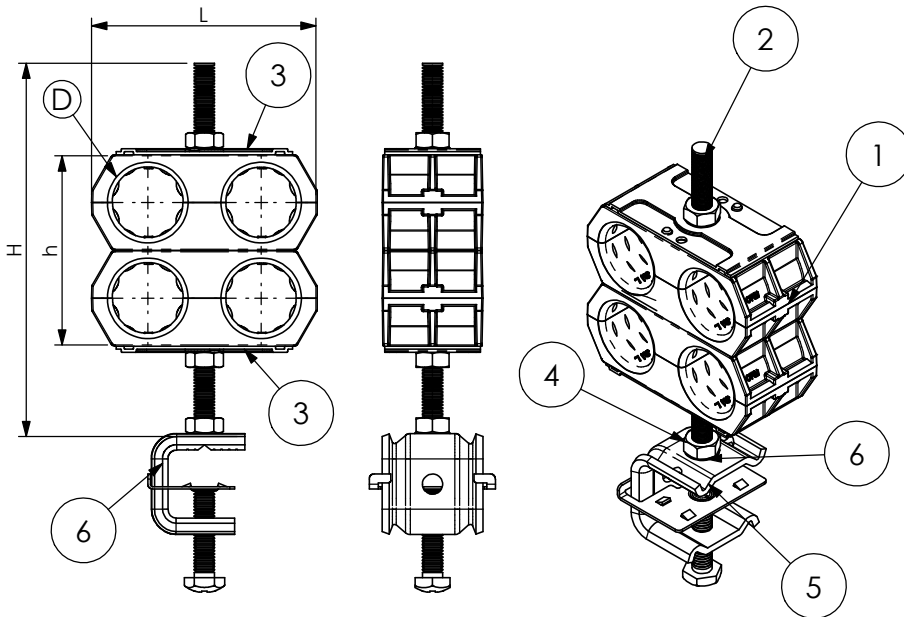

A) SPECIFICATIONS

- 1 Calibrated twin black saddles made in H.D.P.E
- 2 Stainless steel threaded bar BFI M8
- 3 Stainless steel pressure plate PRUC
- 4 Stainless steel hexagonal nut DAI 8
- 5 Stainless steel MCM 8 clamp
- 6 Stainless steel flat Washer REI 8

B) RESISTANCE TESTS

UV Test BS-ISO 105-B06
 Vibration test conforming to UNI 60068-2-6
 Operating temperature: -30°C +120°C

C) PACKAGING INFORMATION

Packing in boxes.
 Label indicating:
 product code, article, quantity,
 production batch,
 FIMO logo and figure.
 (Customer code on request).

D) MOUNTING INSTRUCTIONS

On request

CODE	ARTICLE	ø D	L	h	H	BOX	WEIGHT
61 1560 0409	UCC/ 4x9	8 - 9	56	100	42	20	390
61 1560 0411	UCC/ 4x11	10 - 11	56	100	42	20	230
61 1560 0413	UCC/ 4x13	12 - 13	56	125	54	20	230
61 1560 0414	UCC/ 4x1.2" S (14)	13 - 14	68	125	54	20	260
61 1560 0438	UCC/ 4x3/8" (16)	15 - 16	68	125	54	20	260
61 1560 0412	UCC/ 4x1.2" (17)	16 - 17	68	125	54	20	260
61 1560 0458	UCC/ 4x5/8" (23)	21 - 23	90	150	76	20	260
61 1560 0478	UCC/ 4x7/8" (28)	27 - 28	90	150	76	20	340
61 1560 4118	UCC/ 4x1.1/8" (38)	36 - 38	114	200	108	20	340
61 1560 4114	UCC/ 4x1.1/4" (40)	39 - 40	114	200	108	20	400
61 1560 4148	UCC/ 4x1.5/8" S (49)	48 - 49	137	250	132	20	404
61 1560 4158	UCC/ 4x1.5/8" (52)	50 - 52	137	250	132	20	400

RI	DATE	DR	DATE	AP	Description:
02					Cable Clamp type UCC +MCM 8 Clamp
01					
00	03/11/2015	G.S.	03/11/2015	A.V.	
1 ST EMISSION					
					Use: Fastening of 4 cables on flats, rounds and angulars